

# ME

# 05

# 06

## MECHANICAL ENGINEERING 2005-2006 ANNUAL REPORT

# table of conte

Mechanical Engineering Annual Report • 2005-2006

**Message from the Chair** .....2

## Expanding Educational Opportunities

ME Undergraduate Program Earns High Marks from ABET	.4
Energy in the Curriculum	.5
Hands-On Design Curriculum Teaches Problem-Solving	.6
UM-SJTU Joint Institute Hosts First Students and Names First Dean	.8
U-M and KAIST Partnership Expands	.9
First International Engineering Summer School a Success	.10
New Course and Textbook Make the Business Case for Responsive, Global Manufacturing	.11
Course Prepares Students for International Teamwork	.12
PhD Degrees Granted	.14



## Accelerating Technology Development

Advances in Biosystems Promise Health, Quality of Life Improvements	.16
A Novel Biosensing Platform for Pathogen Detection	.18
Rapid Prototyping for Advanced Applications in Medicine and Energy	.19
Large Advances in Small Technology	.20
Nano-Scale Combustion Science	.22
Hong Im Joins Effort to Form New Collaborative Center	.23
Furthering Fuel Cell Technology	.24
From Cells to Cars, the Heterogeneous Multiscale Materials Lab Looks at Power	.25
Large-Scale Friction Drag Experimentation	.26
Dowling, Schultz Develop Washing Machine Simulations	.27
Environmental Policy, Auto Design and Materials Flows Project Finds its MUSES	.28
Low Temperature Engine Combustion Consortium	.29
Optical Engine Yields Insights	.29
Automotive Research Center Advances Vehicle Modeling Technology	.30
GM CRL Accelerates the Development of Highly-Efficient and Ultra Clean Engine Systems	.31
UM/GM Form Collaborative Research Laboratory for Smart Materials and Structures	.32
Insights Into Elastomeric Deformation	.33
Creative Approaches to Vehicle Safety	.34



# nts

UMTRI Projects Accelerate	.35
New MEng Program off to a Quick Start	.36
Changes in the Guard	.36
Department Statistics and Trends	.38
Reconfigurable Manufacturing Systems ERC Transfers Technology	.39
High School Students in Italy See Factory Testbed in Action	.40
Wee Wizards to Inspire Future Engineers	.41
New Directions in the S.M. Wu Manufacturing Research Center	.42
Center for Lasers and Plasmas Advances Manufacturing Technologies	.43

## Achieving Excellence

Galip Ulsoy Elected to NAE	.44
Jun Ni Honored with Sam Wu Professorship	.45
ME Manufacturing Sets the Pace with Awards	.46
Alan Wineman Receives Distinguished Faculty Achievement Award	.47
Jwo Pan Named SAE Fellow	.48
Hong Im Receives Ralph R. Teetor Award	.48
Krishna Garikipati Completes Humboldt Fellowship	.49
Ellen Arruda Named Centennial Fellow	.49
Get to Know New ME Faculty	.50
Faculty Honors & Awards	.52
Epureanu, Ulsoy Earn Outstanding Achievement Awards	.53
Faculty Promotions	.53
Donors & Research Sponsors	.54
William W. Schultz Appointed to NSF Post	.55
Professor Michael M. Chen Retires	.55
Staff Complete 40 Years of Service	.56
Marcy Brighton Chosen as Finalist for Distinguished Staff Service Award	.57
MRacing Team Takes Third	.58
Undergraduate Student Honors & Awards	.59
Graduate Student Honors & Awards	.60
ME Graduates Receive Faculty Appointments	.62
Global Perspectives from ME's External Advisory Board	.66
ME Welcomes New EAB Members	.67
EAB Member Taub Elected to NAE	.68
Ray Wilcox Wins Alumni Society Merit Award	.68

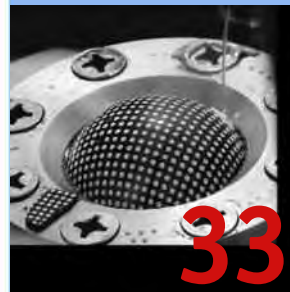
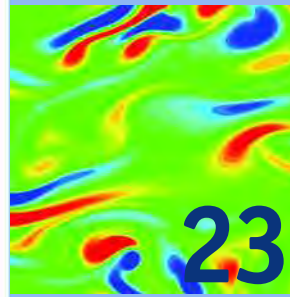

ME  
05  
06

# Message from the Chair

**I**t truly feels like “only yesterday” that I assumed the position of the ME Department Chair in January 2002. As I reflect on the past year — and, inevitably, the past five years — I am filled with both pride and humility. It has been an honor to lead the ME Department during a period filled with so many accomplishments. At the same time, I am standing in awe of what the combined talents, knowledge and dedication of the entire ME team — composed of 70 professorial and research faculty members, 55 staff members, 1,200 students and over 16,000 alumni — can achieve. It is indeed a pleasure to reflect on some of the highlights of the last year in our annual report

The Mechanical Engineering undergraduate program, ranked 4th in the country by US News and World Report, has grown to become the most popular choice among the students in the College of Engineering. As the ABET review committee commented in its final report last year, “the ME Program has done an outstanding job of articulating the linkages of its curriculum to its objectives and those of the College and the University. The program has in place a well-defined and vigorous plan by which its students, alumni, faculty and administrators are involved in the measurement, evaluation and improvement of its program.” Our graduate program, ranked 5th by US News and World Report, continues to enjoy a strong national reputation and to attract a diverse and extremely motivated student body from all over the world. Our all-time high enrollment is a testimony to the strength of our curriculum and the breadth of our research portfolio. Students strike me as creative, enthusiastic, tireless in their academic and extracurricular pursuits, and . . . smart! If these are the engineers of the future, I know we are in good hands. Our alumni are playing leadership roles in industry, government and academia. In fact, recent ME graduates are landing faculty positions at some of the nation’s and world’s top engineering schools.

The ME faculty are dedicated to teaching and mentoring our students through impressive and innovative curricular offerings. Hands-on engineering is a hallmark of the ME Department’s design and manufacturing

science curriculum. Building on our successes, we have introduced a new theme-based approach to provide students with additional opportunities in their ME 450 major design experience. In response to the pressing need to educate engineers to address the daunting energy challenges that the world is facing, we have developed three new courses on energy technologies and power generation. ME has also played a central role in the successful launch of the new college-wide M.Eng. degree in Global Automotive and Manufacturing Engineering. Other courses, including Global Product Development and Global Manufacturing, ensure that our students learn how to carry out engineering principles in multiple, global contexts and perspectives. Several international programs also offer students

opportunities to live and work abroad, including the SJTU - UM Joint Institute that has been launched in 2006, as well as a strong partnership with the Korea Advanced Institute of Science and Technology and the International Engineering Summer School in conjunction with TU Berlin.

Paralleling the success in its educational mission, the ME Department has been prolific in research, making strides in fundamental ME science while extending the boundaries in emerging disciplines. At the same time, ME has continually put theory into practice, “translating” laboratory breakthroughs for industrial and clinical settings. The fact that the ME department has secured once again over \$27 million in research funding this year, at a time of severe financial constraints and budget cuts, shows the strong support and



Department Chair Dennis Assanis with U-M Provost Teresa A. Sullivan and College Dean David C. Munson, Jr. during a visit to the W.E. Lay Automotive Laboratory.



confidence of both public and private sponsors in the work done in our Department. Committed to addressing grand societal challenges — energy, environment, health, quality of life, national security — our faculty have pioneered research in critical and emerging areas, including energy systems, bio-systems, micro/nano-systems, while continuing to innovate as a means to enhance the competitiveness of the automotive and manufacturing industries.

The ME Department expanded its horizons this year with the hiring of four faculty members working in MEMS, bio-systems, energy-systems and nano-technology. Kathleen Sienko focuses on designing MEMS-based implantable devices and in carrying-out experiments involving human subjects to quantitatively assess clinical condition, sensory substitution and human ability to interact with machines. Kenn Oldham's research interests are in fundamentals of dynamics, control systems and electromechanical design, and the blending of design, fabrication and controls in MEMS. Shorya Awtar's interests are in precision engineering and mechatronics, with emphasis on applications at the micro and nano-scales. John Hart creates new methods and machines to synthesize nano-structured materials, control the underlying mechanisms of growth reactions, and develop energy-related applications of those materials.

Our new faculty will be in stellar company. ME faculty, again this year, have earned numerous awards and distinctions. Among those honored, our colleagues in the field of manufacturing have been recognized for not only conceiving new paradigms in manufacturing and establishing them as scientific disciplines, but also for incorporating them into industrial practice. Professor Galip Ulsoy was elected to the National Academy of Engineering — the top honor in engineering — for his work on the dynamics of axially moving elastic materials and their implementation in automotive and manufacturing systems. Professor Jun Ni, the inaugural dean of the Shanghai Jiao Tong University - UM Joint Institute, was named the Shieng-Min (Sam) Wu Professor of Manufacturing Science. And two ME professors earned prestigious manufacturing awards from the American Society of Mechanical Engineers: Yoram Koren, the M. Eugene Merchant Manufacturing Medal; and Jyotirmoy Mazumder, the 2006 William T. Ennor Manufacturing Technology Award.

This past year, our two ME Associate Chairs, Professor Greg Hulbert and Professor Arvind Atreya, who have been the Directors of our Undergraduate and Graduate Programs since June 2002 and September 2003, respectively, have completed their terms of service. Thanks to their fairness, sound analytical judgment and unselfishness, they have both served the ME Department and our students with a great sense of responsibility and dedication, and significantly contributed to the excellence of our academic programs. Replacing Greg and

Arvind, our new Associate Chairs, Professor David Dowling and Professor Karl Grosh, bring their energy and enthusiasm to our Academic Service Office and the ME Department's administrative team since January 2007.

It is impossible to be as productive a department as we have been without dedicated staff. Marcy Brighton, who served as the ME Department's Administrative Manager since 2000, was chosen as a finalist for the University's 2006 Distinguished Service Award. We wish her the best in her new position as Director of Financial Planning and Management in the College of Engineering, a well-deserved promotion. We welcome on board Merlis Nolan as the new ME Administrative Manager and look forward to working with her. And we are thrilled to recognize Lynn Buege, Arlene Schneider and Sue Gow on their 40 years of loyal service to the University, many of them spent in ME.

Success does not come without challenges. One of the consequences of our growth in enrollment and personnel, our curricular innovations, and the expansion of our research into emerging areas has been the increasing need for additional and different in nature lab, classroom and office space. As the culmination of strategic planning efforts over the past three years, a major addition and remodeling of GG Brown Laboratory at an estimated cost of \$125M has emerged as one of the highest top priorities in the five year, all campus master plan. This planned expansion will allow the ME Department to remain competitive with peer institutions, continue to provide top-notch engineering talent, support manufacturing and industry in the state, and conduct research in important fields such as energy and nanotechnology. While significant effort remains ahead to transform this vision into reality, the first step has clearly been taken.

As many of you know, I will be stepping down from the position of ME Chair at the end of the 2006-07 academic year. I am grateful for the time I have served leading our Department through a period of rapid change for the world and for Mechanical Engineering education, research and practice. I feel that our collective accomplishments have strategically positioned ME to face the challenges of the future. Though the work never ends, I am confident that our ME Department will continue to *build upon our current foundation of excellence to take the lead, nationally and internationally in defining the future of Mechanical Engineering*. In closing, I wish to sincerely thank all of you — dedicated faculty and staff, hard working students and loyal alumni — for your trust, support and collaboration all these years.

*Dennis N. Assanis  
Chair, Mechanical Engineering  
Jon R. and Beverly S. Holt Professor of Engineering*

Krishna Garikipati's work focuses on the development of mathematical and numerical models for growth and remodeling of biological tissue. Shown is an initially uniform medium developing distinct phases.

welcome

# ME Undergraduate Program Earns High Marks from ABET

The ME department's undergraduate program earned full accreditation from the Accreditation Board for Engineering and Technology, or ABET, in 2005. The next review will be conducted in 2011.

During an on-campus site visit in October 2005 ABET reviewers spent two-and-one-half days talking with faculty and staff, visiting laboratories and meeting with a cohort of students. The process also involved a program self-assessment, curricula reviews and evaluation of numerous other criteria.

Although the actual on-site review takes place once every six years, assessment and improvement are ongoing, according to Professor Gregory Hulbert, undergraduate program director. "It's not a one-time event when ABET reviewers are here," he said. "We're always evaluating and improving our program — that goes on all the time."

In its final statement ABET reviewers noted several ME program strengths, including its continuous improvement plan. In addition the

undergraduate program has become the most popular among first-year students declaring majors in the College. Enrollment in 2005 was 573; the program conferred 229 bachelor's degrees. Based on information from alumni surveys, more than 75 percent of graduates earn advanced degrees within a decade of receiving their diplomas.

Fifty one faculty members teach in the program; nine are women, and three of the nine are full professors, "which places it near the top of the gender-friendly mechanical engineering programs in the nation," according to the statement.

Reviewers also noted that the program "has done an outstanding job of articulating the linkages of its curriculum to its objectives and to those of the College and University."

"We have a set of objectives for the undergraduate program," said Hulbert, "and we set those in a way that they do align with those of the College and University." One of those objectives involves building teamwork

skills among students. "The ability to work in teams is one of the two most important job skills students need upon graduation and in the working world. Our curriculum delivers [those skills] through five courses where students work in teams. We place a very strong emphasis on helping our students get that experience while they're here."

Reviewers also specifically noted that ME450, Design and Manufacturing, "provides students with an outstanding major design experience." The final statement praised the detailed lectures, the quality of guidance instructors provide to student teams and the teams' final project reports (see story on page 6, "Hands-on Design Curriculum Teaches Problem-Solving").

"The reviewers recognized the strengths of our program," said Hulbert. "It's rewarding to see that the things we've been very deliberate about during the past six years (since the last review), and even longer, are visible and were recognized by the accreditation team."

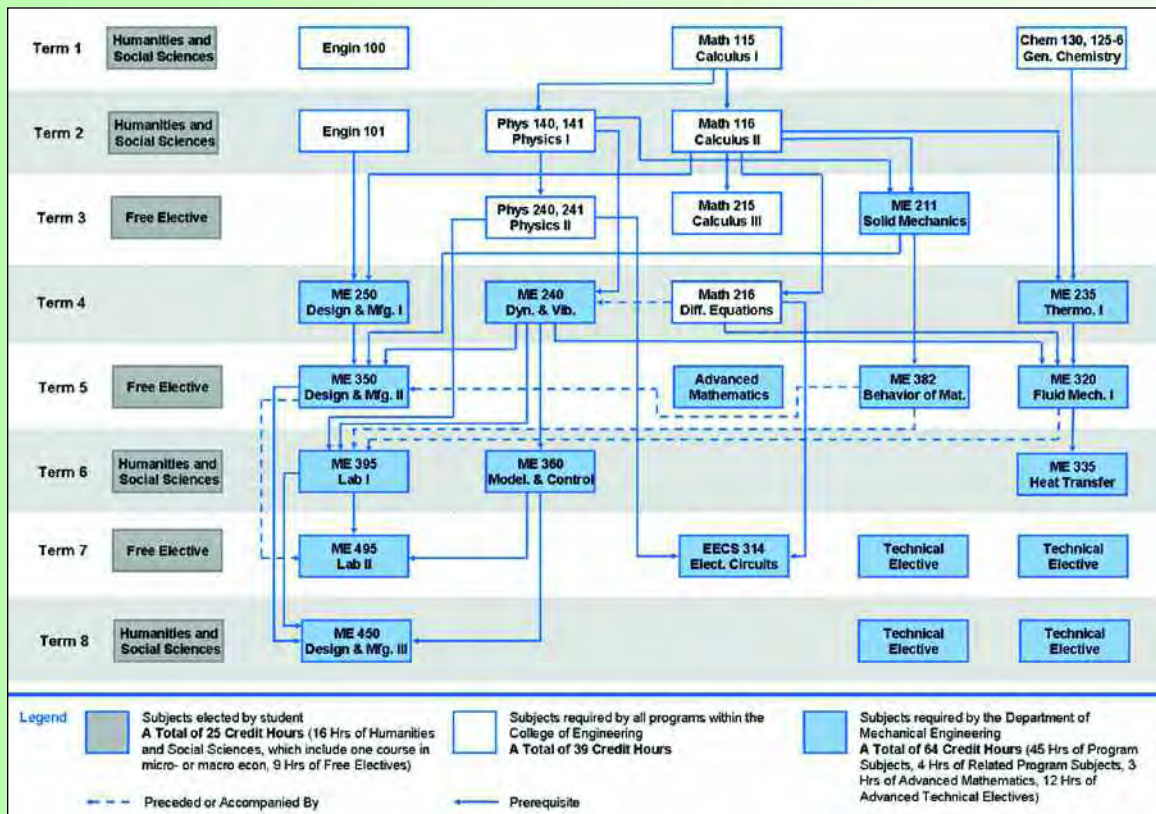

ME undergraduate curriculum flowchart.



# ENERGY IN THE CURRICULUM: Powering the Mechanical Engineer's Vision for New Technologies

**A** population of up to 9 billion people. Eighty percent of the world's population inhabiting sprawling megacities. The future of energy needs circa 2050 poses a daunting set of technical challenges for the generation of engineers presently in school, and the generations to come. Siting of new power generation facilities, whether coal, nuclear or renewable sources, will require unprecedented efforts in new design, at the materials, device and power systems scales. Mechanical engineers are at the forefront of innovation, realization and optimization of power sources, and moving toward our shared national objective of energy independence.



**An exploding population poses a daunting set of energy challenges for the generations of engineers to come. ME faculty have developed three new courses to help find solutions. The courses address both fundamental science and new device development in order to meet future global energy needs.**

At U-M our traditional curriculum is being reenergized by three faculty with active interests in the field, who are translating their laboratory know-how into useful coursework for the future generation: Professor Ann Marie Sastry, Assistant Professor Angela Violi and Associate Professor Margaret Wooldridge. The three new courses developed by these faculty are meeting the needs of the new generation for fundamental scientific understanding, coupled with device know-how. These offerings are complemented by a new degree program planned for the College of Engineering and a short course planned collaboratively by three departments, led by Sastry.

The undergraduate course, ME499: Advanced Energy Solutions, comprises a survey of energy technologies for undergraduates wanting to work in the energy sector. The course taught by Wooldridge, meets a very real need for perspective, as evidenced by its popularity (40 students enrolled in its first semester). “Our undergraduates are strongly motivated to be a part of global solutions to energy demands,” said Wooldridge, whose expertise ranges from airborne pollutant emissions to designing advanced synthetic fuels. “And they have been heavily recruited and have enthusiastically applied to jobs in the energy sector. Our core curriculum provides an excellent basis in fundamentals of thermodynamics — the study of energy transfer. This new course provides a birds-eye view for these budding energy technologists.”

Violi, whose expertise ranges from multiscale simulations of nanoparticle growth and self-assembly to applied chemical kinetics, is aiming her course, ME599: Fundamentals of Energy Conversion, at students seeking a deeper understanding of the molecular basis of energy efficiency and generation rate. “Linking education in thermodynamics to our understanding of the key molecular mechanisms in energy transfer is an exciting opportunity to convey the potential of rate-based analysis in energy technologies. Barriers at this point are not only in devices, but in the fundamentals of materials interfaces,” she said, “and building a bridge between equilibrium and transient analyses is a key objective of the course.”

A graduate course aimed at providing students with comparative metrics for energy technologies, developed by Sastry, was taught to near-perfect evaluations by students in the Winter '06 semester. “Device analysis begins and ends with a thorough understanding of energy transfer in materials,” said Sastry, who works in energy technologies ranging from engineered to biologically-based devices. “In fact,” she added, “many technologies that are now receiving the most attention have been around since Edison. The difference is in implementation with new materials. In this course, students who have elected to work in these technologies are being given the analytical skills to compare technologies and not only deepen their understanding of their own work, but also to select the technologies they will work on next.”

With its central role in engineering, ME is well-positioned to coordinate offerings for the College of Engineering. A new degree program, the Master's in Energy Technologies, is planned for discussion and implementation in the next year, led by Sastry, with participation by at least five other departments. “Continuing education for our students is essential as engineers are retrained in emerging areas,” said Sastry, “and so we are meeting this need through formal degree programs and through shorter-term offerings.”

This phenomenon models processes during embryogenesis in biology, planet formation in cosmology, and phase separation of alloys.

# Hands-On Design Curriculum Teaches Problem-Solving

**H**ands-on experience is a hallmark of the ME department's design science curriculum. In ME350: Design and Manufacturing II, students in Professor Sridhar Kota's class were recently given two springs and asked to design — and demonstrate — a novel catapult mechanism. After a lengthy analysis of spring forces, they built their prototypes and tested them in the field. Kota assigned grades based on how far the mechanism launched a tennis ball and with consistent accuracy.

"In all of my other classes, the situations are scripted in a textbook," said Claire Carpenter, a junior, who took the course in her sophomore year. "In ME350, it was real-world. As we prototyped our design, it became clear that what we thought was an ideal solution on paper was not going to give optimal results. It was up to the students to figure out the best way to solve the problem."

Kota says the course emphasizes mechanical system design rather than simply component design in order to provide students with context. "If all that students learn is how to design parts, they just end up doing end-of-chapter problems, rather than creative system design."

This year Kota added a second major design project — in addition to weekly homework assignments and exams. He gave each student team an orbital jigsaw, which students had to take apart, model and analyze. Then they had to suggest improvements and develop a new motor shaft bearing. Kota's goal was for the class to understand "why products are designed the way they are — not only to understand the calculations but the tradeoffs that have to be made."

"My favorite project of the semester was definitely modeling the orbital jigsaw in MSC.ADAMS software," said Andrew Mansfield, a junior who took the class in his second year. "We ran tests on the model to determine cutting power and forces felt by the user, which was quite amazing to me," he said.

Students submitted papers and, at the end of the project, had to verify that they'd reassembled the jigsaw properly. The entire class was successful. Teaching assistants



(Above and opposite) Students in Professor Sridhar Kota's ME350 class learn about design by disassembling orbital jigsaws, suggesting improvements and designing new parts.

Michael Cherry and Brian Trease "really made it possible for the class to complete a project like this," Kota said.

## ME452: Design for Manufacturing

Kota also teaches ME452, Design for Manufacturing, which covers manufacturing processes and engineering design guidelines for optimal performance. The highlight of this course is students' dissection of common objects — from egg beaters and dishwashers to weed whippers. They analyze the components and how they're made, review patent materials, conduct customer surveys and analyze the competition. "There's a pretty extensive analysis we go through," said Kota. Then students design an improved version, ideally with fewer parts and a shorter assembly time as well. They build a prototype, test it and write a business plan. The project is "intensive," he said. And yet enrollment is consistently high.

The course is offered to working professionals off-campus too, thanks to the work of Adjunct Assistant Professor Donald Malen.

## ME450: Capstone Design and Manufacturing

When Associate Professor Steven Skerlos joined the U-M faculty in 2000, he got involved with the department's capstone design and manufacturing course right away. "The program at U-M just blew me away in terms of what it tries to achieve — and does achieve. It really impressed me."

Skerlos wasn't alone. During its on-site visit, ABET reviewers found that the course provides students "an outstanding major design experience....The attention to the details in the lectures and the projects, including the quality of the guidance provided by the instructors, plus the quality of the interim and final reports prepared by the students, are excellent."

Students work in four-person teams. Seven instructors assign each team one of 35 sponsored projects. About half the projects are sponsored by industry, and half by faculty. Each project involves a design challenge, "a challenge that, coming into it, there's no obvious solution," said Skerlos. And that's the goal.



“We’re trying to teach design by process. Students have to solve the problem. That’s the lesson: design is a creative process, but there are real-world trade-offs, such as time pressure or cost constraints.” Students have 14 weeks to develop, analyze and model a concept, build a prototype and demonstrate that it works.

This year course instructors introduced a new theme-based approach, with each instructor teaching analysis methods focused in his or her thematic area, including sustainable energy and conservation systems and compliant systems design.

*“We’re trying to teach design by process. That’s the lesson: design is a creative process, but there are real-world trade-offs, such as time pressure or cost constraints.”*

The themed approach will give students additional opportunities to learn design analysis approaches. It will also engage a broader swath of faculty members. “Why not leverage the passions faculty have for their area of ME and let them develop themes within 450 to take it to the next level?” Skerlos said.

Finally the theme-based approach will allow richer engagement with sponsors since projects will be able to evolve from previous work. “Rather than a shotgun approach where we find new projects each year, we will be able to have deeper relationships with specific companies,” he said. “No one company will ever own a large number of projects, but if they can sponsor a theme and allow creativity, everyone wins. Whatever skill set they’re interested in, they’ve got an obvious pool of talent not trained the same way anywhere else in the country.”

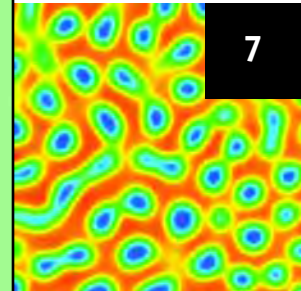

# UM-SJTU Joint Institute Hosts First Students and Names First Dean

In April 2006, representatives from the University of Michigan and Shanghai Jiao Tong University (SJTU) publicly announced the establishment of The University of Michigan-Shanghai Jiao Tong University Joint Institute. The “Joint Institute, or JI, is based in Shanghai, a vibrant Chinese city, said Professor Jun Ni. Ni has been appointed the first dean of the Joint Institute.

The goal for the new institute is to produce world-class, global leaders in engineering — and in other disciplines in the near future. “Given the emergence of this part of the world and scientific and economic developments, many of the companies hiring our students have a pressing need to support their operations globally,” said Ni. “Students also have a strong desire to gain work experience in China, to learn the language and immerse themselves in the culture. We’ve been seeing increasing numbers of students applying to our summer program, which is a strong indicator.” Close to 40 students and nearly a dozen faculty members throughout the College of Engineering studied or taught in Shanghai during the summer of 2006.

The JI allows U-M to create an international education and research base for significant numbers of undergraduate and graduate students to conduct research, study, work and live in China. Faculty will be able to explore new frontiers in their research, including the effects of rapid economic and technological development on their areas of focus. They will have increased opportunities to collaborate with faculty, scientists and industrial engineers in China. “Rapid development affects advanced energy systems, environment and water resource management strategies, urban planning,



U-M representatives to the UM-SJTU Joint Institute board of directors with the visiting Chinese Vice Minister of Education in May 2006.

transportation, telecommunications and many other areas. The unprecedented speed of growth and rate of change raise many new issues and create research opportunities we haven’t seen before.”

The JI currently offers bachelor, master and doctoral programs in engineering through on-site coursework and distance education. Program curricula mirror those at U-M so that students can attend the JI without increasing their overall length of study. As the institute hits its stride in the next few years it will admit 400 undergraduates, 200 master’s candidates, 100 doctoral candidates and 30 post-doctoral scholars annually.

Faculty recruitment is underway, and it is Ni’s goal to earn Accreditation Board for

Engineering and Technology certification within five years. Courses will be taught in English, but students who don’t currently speak Chinese will be able to learn the language through specially designed classes. “We want students from U-M and SJTU to study side-by-side and even live in a shared dormitory environment so that they have a total immersion experience,” said Ni.

Such an experience is critical to students’ education and professional growth and development. “All major U.S. companies have a presence in China,” he said, “and not only for factory production but R&D too. These companies are looking for the JI to be a resource they can tap into for talent.”



# U-M and KAIST Partnership Expands

The partnership between U-M's Department of Mechanical Engineering and the Korea Advanced Institute of Science and Technology, or KAIST, began in 2001. Five years later the program has come into its own, with high levels of participation from both universities and many opportunities for faculty and student collaborations. Associate Professor Hong Im of U-M serves as program coordinator along with Professor Sangmin Choi from the mechanical engineering department at KAIST.

As part of some new activities underfoot, Im spent four months at KAIST as a visiting professor. He is working on a collaborative research project with Professor Sejin Kwon of the KAIST Department of Aerospace Engineering on the development of micro-combustors assisted by catalytic reaction for fuel cells and fuel processor applications.

During Im's stay, he also worked to solidify a student exchange program between the two institutions. Once in place, KAIST undergraduates will be able to study at U-M, and U-M undergraduates will be able to spend a semester or year abroad at KAIST. The first students to participate in the new program, according to Amy Conger, U-M's associate director of International Programs, will be heritage speakers who can take courses in Korean. Students without a Korean language background will be able to choose courses from a list of those offered in English. "From an International Programs standpoint," said Conger, "we've received excellent cooperation from KAIST staff, who are eager to host U-M students, and we've identified several courses offered there that would satisfy U-M degree requirements."

KAIST is also developing an English summer engineering program that may be available to U-M students as early as summer 2007.

"This is one of our newer partnerships, and we're looking forward to watching it grow," said Conger.

In addition, during the 2005-2006 academic year, four KAIST students of Professor Soohyun Kim visited Associate Professor Edgar M yhofer's lab for a one-year research collaboration.

About two dozen students and faculty from both universities participated in the annual Graduate Symposium held October 29, 2005.

Several papers resulting from joint research projects were accepted or published, including "Nonlinear Vibration of Sheet Metal Plates Under Combined Parametric and External Excitation in Sheet Metal Manufacturing" in the *Journal of Vibration and Acoustics*; "Effects of Heat and Momentum Losses on the Stability of Premixed Flames in a Narrow Channel" in *Combustion Theory and Modeling*; and "Sharing CAD Models based on Feature Ontology of Commands History" in the *International Journal of CAD/CAM*.

Faculty from both universities participated in the "Fifth KAIST-UM Workshop on New Opportunities in Mechanical Engineering Education," held December 14-16, 2006, in Honolulu, Hawaii. U-M participants included Professors Dennis Assanis, Arvind Atreya and Ann Marie Sastry; Associate Professors Hong Im and Margaret Wooldridge; and Research Associate Professor Zoran Filipi.

Professor Huei Peng, director of the Automotive Engineering Program at U-M, met with faculty and administrators at KAIST's Graduate School of Automobile Technology to discuss a future collaboration in Automotive Engineering education programs at both institutions.

"As is evident in these joint efforts," said Im, "the UM-KAIST collaboration program has matured to a significant level now, and we are looking forward to seeing some more visible accomplishments in the next few years."



Participants in the Fourth Annual KAIST-UM Joint Workshop.

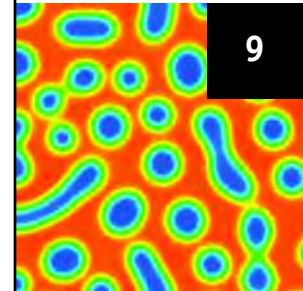

# First International Engineering Summer School a Success

The first International Engineering Summer School (IESS) at Technische Universität Berlin took place over a six-week period in June and July 2006. The program was developed by ME Professor Volker Sick at U-M and Professor Frank Behrendt of TU Berlin. The initial three years of the program are supported by DAAD, the German Academic Exchange Service.

Eleven first and second-year undergraduate students from U-M's College of Engineering

and aerospace museums, a BMW motorcycle factory and public viewing areas of World Cup soccer games.

The program was tremendously successful, according to Sick. The goals he and Behrendt had set for the students — learning basic German, gaining insight into German history, culture and politics, conducting engineering project work, making contact with companies for future internships abroad — were all accomplished. Some of the students are

impressions about the program and discuss long-term plans for the partnership. Stacie Edington, International Programs advisor, was also instrumental in recruiting and advising prospective students on a wide range of topics, including credit transfer to their U-M degree program. A delegation from the DAAD international advisory board, which oversees ten U.S.-Germany summer school partnerships, visited the IESS and was “favorably impressed,” Sick said.

Conger says she's particularly excited that the program is open to first- and second-year students. “It's an extremely well-organized program that gives students a taste of overseas study early in their U-M careers and allows time to incorporate another semester or internship abroad before they graduate. Upon return, students can take additional German courses while earning their engineering degree. It's one of those innovative programs that breaks the mold of the traditional ‘junior year abroad.’”

The IESS program is the highlight of a long-standing partnership with TU Berlin. Sick has worked with professors at TU Berlin to co-supervise graduate theses and overseas research internships for students enrolled in both institutions.

Sick believes that the true, full value of the IESS will continue to reveal itself for years to come, “as students recognize how much this early experience with international education, engineering and friendship determines the course of their life and career.”

Second-year ME major Lindsay Klick is already appreciating the experience. “I loved the summer school at TU Berlin,” she said. “The German class was great because we learned some basic phrases to get around the city. The engineering labs were really interesting, too. It was fun getting to know other students from school and exploring Berlin together and just experiencing the city. The little group excursions that we were taken on to BMW, Volkswagen and the Baltic Sea were probably my favorite part of the program. It was all-around an amazing experience and I would do it again in a heartbeat.”



College of Engineering participants in the first International Engineering Summer School at Technische Universität Berlin.

*“The IESS program in Berlin, Germany, was one of the best experiences of my life... Not only did I learn a lot in Germany, I made friendships that will carry back with me to U-M.”*

—Michael Haigh, U-M, *Engineering undeclared*, 2009

and the College of Literature, Science, and the Arts participated, almost half of whom were from the ME department. Four TU Berlin faculty and their assistants coordinated lab-based research projects for small groups of students. When not in the lab or in language training, students participated in numerous excursions, including visits to navy

already planning to continue their German studies and return to Berlin for internships or research projects.

Associate Dean for Graduate Education Stella Pang and Associate Director of International Programs Amy Conger also supported the IESS project. Pang and Conger visited TU Berlin to meet with students, get first-hand



# New Course and Textbook Make the Business Case for Responsive, Global Manufacturing

To better prepare today's engineering students for the challenges and requirements of globalization, Professor Yoram Koren has developed a new course and written a new textbook. The course, Global Manufacturing (ME587 and MFG587), was offered for the first time in the Winter 2006 semester. It will be a regular offering beginning with the Fall 2007 semester.

Koren, who directs the National Science Foundation Engineering Research Center for Reconfigurable Manufacturing Systems, developed the course and book to address the myriad issues globalization presents for engineers in the manufacturing arena. Those issues relate to three main areas: product design for a global marketplace, manufacturing and business management, and more importantly, their integration. As a result they require new paradigms in order for U.S. engineers to compete and succeed. "Like it or not, globalization is here," writes Koren, "and has a direct impact on industry, as well as on the economy and our life."

Koren's book, *The Global Manufacturing Revolution: Product-Process-Business Integration and Reconfigurable Systems*,

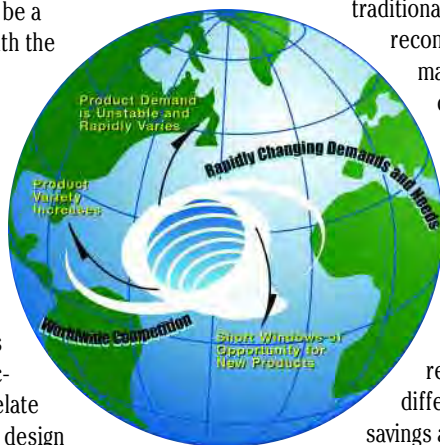

This image illustrates the turbulent nature of global manufacturing. Fueling the system are rapidly changing desires and global competition. The outputs are resulting challenges that must be addressed.

serves as a key text for the course. Both begin with a lay of the globalized manufacturing landscape, with discussions of business models for globalization and product invention strategies. Next come analyses of mass and lean production and mass customization, followed by a discussion of traditional manufacturing systems. Koren then covers reconfigurable manufacturing systems and reconfigurable machines, which allow companies to remain competitive by being agile and responsive to the changing demands of multiple markets around the world. Chapters on strategic planning and organizational design round out the text.

Students enrolled in the course were assigned a semester-long strategic product development project. They identified products whose market share could be significantly increased if designed or redesigned with variations that fit the needs of different customers and took advantage of the cost-savings and efficiencies gained by production with a reconfigurable manufacturing approach. Students took their ideas all the way from conception to simple business plan.

Koren is credited with transforming the manufacturing engineering field by developing a new generation of manufacturing systems. He has been elected to the National Academy of Engineering and has been recognized with numerous prestigious awards and honors (see story on page 46, "ME Manufacturing Sets the Pace with Awards"). He is also the author of *Computer Control of Manufacturing Systems*, published in 1982, which presented the fundamentals of computer numerical control. His work contributed to CNC's emergence as both a research and educational discipline.

## Students say:

"Overall, as an off-campus student, I think the course was excellent. I would strongly recommend it to anyone. It was particularly invaluable for me because I believed in the same core philosophy before I took the course. I have been working in product development for 7 years (product), and a few years ago I chose to pursue my master's in manufacturing (process). Now as I am close to graduation I am applying to business school (business model). This will help me complete the circle of knowledge and skills I seek and lay the foundation for starting my own company."

"I really enjoyed the class. As a business student, it gave me the chance to learn more about manufacturing and interact with engineering students. The project was very practical and gave the chance to see the whole picture of a business case."

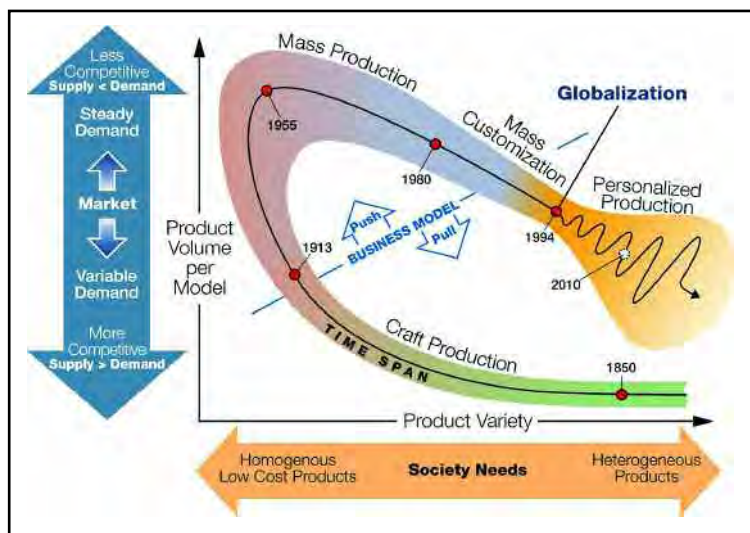

Graph showing changing paradigms of manufacturing through history. The course starts (bottom right) with the craft paradigm where every product is made one at a time. Mass production expands product units made but allows for limited types of products. Recent and future paradigms produce fewer units but offer greater opportunities for customization.

# Course Prepares Students for International Teamwork

*“We never educate directly, but indirectly by means of the environment. Whether we permit chance environments to do the work, or whether we design environments for the purpose makes a great difference.”*

— John Dewey (1933)  
How We Think

At the end of the Fall 2000 semester, Professor Deba Dutta had concerns about the future of a course he had just developed and taught for the first time. The course was called Global Product Realization and, thanks to videoconferencing technology, he taught it simultaneously on three continents. Students gave it high marks, and Dutta knew that the occasional technological glitches were surmountable. But he didn't know if the course itself could be sustained. “I wondered if I was creating a course that was person-specific; I didn't know if anyone else would be willing or able to devote the time and energy to it in the future,” he said.

Six years later the course, called Global Product Development (ME581), is stronger than ever. Lalit Patil, PhD, a research fellow and lecturer in the ME department, has served as course leader for the past two years. “The best part is that I'm *not* involved,” said Dutta jokingly, although he does give occasional lectures during the semester-long course. Since 2004 Dutta has been at the National Science Foundation and the course has involved Drs. Donald Malen, Sridhar Kota and Kazuhiro Saitou, in addition to Patil.

Dutta originally created the course to address a need he saw: to educate engineers for the future by training them to work in distributed, international teams that understand the cultural aspects and impact of engineering problems. More than 250 students in the United States, Europe and Asia have taken the class since he first offered it.

In addition to U-M, participating universities include TU Berlin in Germany and Seoul National University in Korea. Students work in six-member teams, two from each university. They participate in a week-long, in-person meeting at the start of the semester and get together once more for an additional week at

the close of the semester, when they present their collaborative project. In between, team members stay in close communication via email, instant messaging and their own custom-designed communication tools, according to Patil.

A product development project functions as the centerpiece of the course. Students not only conceive of a global product; they must conduct market research, design the item, build a working prototype as well as propose a plan for large scale manufacturing, distribution and financing. The product and its plans must be applicable to two regions of the world — with two sets of cultural requirements that conflict. “It would not be possible for a single version of the product to satisfy both markets,” explained Patil.

Through the project, students learn how to work in distributed teams. Lectures from faculty and invited guests, delivered via videoconferences, cover the product development process and aspects of globalization. There is no textbook; instead students review and discuss case studies from companies, such as Whirlpool, Samsung Electronics, Steelcase, Kodak and Hyundai, that highlight issues they face in the global marketplace.

At the end of each semester, students present their work in the Global Education Forum, a public exhibition. The forum is attended by academic and industry leaders as well as members of the media.

Despite the course's heavy workload, feedback from students has been overwhelmingly and consistently positive. All agree, said Patil, that taking the course has changed how they look at the world. “When we hear that, the purpose of the course is being served and the students are learning, so we know that it can sustain itself.”



### Quotes from student teams

*“Although communicating with our teammates from other countries was challenging, it helped us learn the great benefits of global design. Teamwork comes from understanding other cultures and other ways of thinking. We were all very impressed with the new ideas that came from working with our foreign teammates. It was very good to have different backgrounds and ways of thinking when solving our technical problems.”*

—Team 3 (2005)



Global Education Forum attendees.

*“Each team member learned valuable technical and personal skills. The dynamics and setting of the class are truly extraordinary and we all have had an unforgettable experience.”*

—Team 8 (2005)



Live lectures via video-conference prepare students for the collaborative development of global products.

*“All in all, it was an amazing class. More than just a class, it was an experience that did more than any textbook could to change one’s perspective on engineering design.”*

— Brian Trease (2002)



Students based on three continents meet to work on the course project.

# PhD Degrees Granted

## Winter 2005

### Aristotelis Babajimopoulos

Effects of Temperature and Composition Stratification on HCCI Combustion  
Chair: Dennis Assanis

### Melida Chin

Electrical Contact Resistance of Anisotropic Conductive Adhesive (ACA) Assemblies in Micro-Scale Packaging  
Co-Chairs: Jack Hu & Kaushik Iyer

### Luciana DaSilva

Integrated Micro Thermoelectric Cooler: Theory, Fabrication and Characterization  
Chair: Massoud Kaviany

### Ronald Grover

A Methodology for CFD Predictions of Spark-Ignition Direct-Injection Engine Conical Sprays Combining Improved Physical Submodels and System Optimization  
Chair: Dennis Assanis

### Youngwon Hahn

Development of Mixed Shell Element for 7-Parameter Formulation and Identification Methods of Lowest Eigenvalues  
Chair: Noboru Kikuchi

### Sung-Tae Hong

Mechanical Behavior of Aluminum Honeycombs Under Multiaxial Loading Conditions  
Chair: Jwo Pan

### Timothy Jacobs

Simultaneous Reduction of Nitric Oxide and Particulate Matter Emissions From a Light-Duty Diesel Engine Using Combustion Development & Diesel Oxidation Catalyst  
Chair: Dennis Assanis

### Hamed Khalkhali

Modeling and Design of Compact Thermosyphons for Electronic Cooling  
Chair: Katsuo Kurabayashi

### Taeyong Kim

The Role of Jelly Coats in Sea Urchin Egg Fertilization: A Combined Experimental and Numerical Investigation  
Chair: Ann Marie Sastry

### Sang-Ho Lim

Dynamic Analysis and Design Strategies for Mistuned Bladed Disks  
Co-Chairs: Christophe Pierre & Matt Castanier

### Jie Luo

Machining of Elastomers  
Chair: Albert Shih

### Yuan-Hung Ma

Operation of Manufacturing Systems With Work-in-Process Inventory and Production Control  
Chair: Yoram Koren

### Jeremy Michalek

Preference Coordination in Engineering Design Decision-Making  
Chair: Panos Papalambros

### Tiffany Miller

Combustion Synthesis of Metal/Metal Oxide Nanocomposite Materials  
Chair: Margaret Wooldridge

### Volkan Patoglu

Guaranteed Stability for Collision Detection and Simulation of Hybrid Dynamical Systems  
Chair: Brent Gillespie

### Huan Qi

Synthesis of Designed Materials by Laser-Based Direct Metal Deposition Technique: Experimental and Theoretical Approaches  
Co-Chairs: Noboru Kikuchi & Jyotirmoy Mazumder

### Zimin Yang

Dynamic Maintenance Scheduling Using Online Information About System Condition  
Chair: Jun Ni

### Cetin Yilmaz

Analysis and Design of Uniaxial Passive Vibration Isolators Considering Stiffness and Bandwidth Limitations  
Chair: Noboru Kikuchi

### Fu Zhao

Microfiltration Recycling of Semi-Synthetic Metalworking Fluids: Models, Formulation, and System Design  
Chair: Steve Skerlos

## Summer 2005

### Charles Funk

An In-depth Comparison of Experimental and Computational Turbulence Parameters for In-cylinder Engine Flow  
Chair: Volker Sick

### Hongseok Kim

Investigations for Warm Forming of Lightweight Sheet Materials: Process Operations  
Co-Chairs: Jun Ni & Muammer Koc

### Cheng-Yu Lin

Solid-fluid Mixture Microstructure Design of Composite Materials with Application to Tissue Engineering Scaffold Design  
Co-Chairs: Noboru Kikuchi & Scott Hollister

### Pei-Chun Lin

Proprioceptive Sensing for a Legged Robot  
Co-Chairs: Brent Gillespie & Daniel Koditschek

### Katherine Peterson

Control Methodologies for Fast and Low Impact Electromagnetic Actuators for Engine Valves  
Chair: Anna Stefanopoulou

### Jinzhong Wang

Development of Advanced Methodology for Network-Distributed Simulation  
Co-Chairs: Greg Hulbert & Zheng-Dong Ma

### Geng Zhang

Component-Based and Parametric Reduced-Order Modeling Methods for Vibration Analysis of Complex Structures  
Co-Chairs: Christophe Pierre & Matt Castanier

## Fall 2005

### Sanghum Baik

Modeling and Design Strategies for the Vibration Response of Turbine Engine Rotors  
Co-Chairs: Matt Castanier & Christophe Pierre

### Christos Chryssakis

A Unified Fuel Spray Breakup Model for Internal Combustion Engine Applications  
Chair: Dennis Assanis

### Haseung Chung

Processing and Properties of Functionally Graded Polymer Composites Produced by Selective Laser Sintering  
Chair: Suman Das

### Parag Dixit

Gradient Plasticity Model: Formulation and Implementation Using Vector Finite Elements  
Chair: Krishna Garikipati



**Jiro Doke**

On the Preferred Step Frequencies of Walking: Mechanics and Energetics of Swinging the Human Leg  
Chair: Art Kuo

**Xin He**

An Investigation of Iso-octane Auto-ignition Using a Rapid Compression Facility  
Co-Chairs: Arvind Atreya & Margaret Wooldridge

**Charles John Kim**

A Conceptual Approach to the Computational Synthesis of Compliant Mechanisms  
Co-Chairs: Sridhar Kota & Yong-Mo Moon

**Chul Kim**

Effects of Pressure on the Mechanisms of Soot Formation and Oxidation in Laminar Diffusion Flames  
Co-Chairs: Margaret Wooldridge & Gerard Faeth

**Hyungpil Moon**

Distributed Manipulation Using Naturally Existing Force Fields  
Chair: Jonathan Luntz

**Lalit Patil**

Interoperability of Formal Semantics of Product Data Across Product Development Systems  
Chair: Deba Dutta

**Szabolcs Sovenyi**

Model-Based Cancellation of Biodynamic Feedthrough with a Motorized Manual Control Interface  
Chair: Brent Gillespie

**Li Tang**

Design and Reconfiguration of RMS for Part Family  
Co-Chairs: Yoram Koren & Derek Yip-Hoi

**Yi-Chung Tung**

PDMS-on-Silicon Microsystems: Integration of Polymer Micro/Nanostructure for New MEMS Device Functions  
Chair: Katsuo Kurabayashi

**Ardalan Vahidi**

Constrained Optimal Control Applied in Fuel Cells and Vehicle Systems  
Chair: Anna Stefanopoulou

**Robert White**

Biomimetic Trapped Fluid Microsystems for Acoustic Sensing  
Chair: Karl Grosh

**Chunsang Yoo**

Direct Numerical Simulations of Strained Laminar and Turbulent Nonpremixed Flames: Computational and Physical Aspects  
Chair: Hong Im

**Winter 2006****Paul Alexander**

Dual Electro/Piezo Property (DEPP) Functionally Graded Piezoceramics (FGP)  
Co-Chairs: Diann Brei & John Halloran

**Kuei-Yuan Chan**

Monotonicity, Activity and Sequential Linearization in Probabilistic Design Optimization  
Co-Chairs: Panos Papalambros & Steve Skerlos

**Melissa Chernovsky**

An Experimental Study of Temperature and Radiation Characteristics of Transient Spherical Diffusion Flames in Microgravity  
Chair: Arvind Atreya

**Jaehyug Choi**

Dynamics and Noise Emission of Vortex Cavitation Bubbles  
Chair: Steve Ceccio

**Charles Hoffer II**

In Pursuit of Accurate Structural & Mechanical Osteocyte Mechanotransduction Models  
Chair: Steven Goldstein

**Dongchoul Kim**

Engineering Self-Assembled Nanostructures with Externally Applied Fields  
Chair: Wei Lu

**Gap-Yong Kim**

Microreactor Design and Fabrication of Micro/Meso-Features for Onboard Fuel Processing System  
Chair: Jun Ni

**Taesung Kim**

Nanomechanical Analysis of Microtubule Translocation by Biomolecular Motors in the Presence of Electric and Flow Fields

Co-Chairs: Charlie Hasselbrink & Edgar M yhofer

**Kathleen Klinich**

Estimating Infant Head Injury Tolerance and Impact Response  
Co-Chairs: Greg Hulbert & Lawrence Schneider

**Selin Kurnaz**

Using Operational Flexibility (Lot-Sizing, Scheduling and Sequencing) to Improve Customer Responsiveness in a Manufacturing System  
Co-Chairs: Yoram Koren & Amy Cohn

**Seungjoo Lee**

A Cell Controller Design Methodology Including Error Handling for Flexible and Reconfigurable Manufacturing Cells  
Chair: Dawn Tilbury

**Soo Yeol Lee**

Efficient Probabilistic Vibration Analysis of Complex Structures Using Substructures and Reliability Techniques  
Co-Chairs: Christophe Pierre & Matt Castanier

**Zhijun Li**

Optimal Design of Multistation Assembly System  
Co-Chairs: Panos Papalambros & Michael Kokkolaras

**Jia-Hsuan Lo**

On Minimizing Injury Risk in Forward and Lateral Falls: Effects of Muscle Strength, Movement Strategies, and Age  
Chair: James Ashton-Miller

**Tershia Pinder**

Effect of Velocity and Fuel Concentration Fluctuations on Nonpremixed Jet Flame  
Chair: Arvind Atreya

**Young Rim Seo**

Electro-Magnetic Blank Restrainer  
Chair: Jim Barber

**Kabir Udeshi**

On-Chip High Voltage Generation Using Mechanical Oscillators  
Chair: Yogesh Gianchandani

**Bin Wu**

Using High-Fidelity Simulations and Artificial Neural Networks in Calibration and Control of High-Degree-of-Freedom Internal Combustion Engines  
Co-Chairs: Dennis Assanis & Zoran Filipi

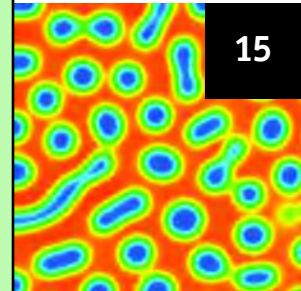

# Advances in Biosystems Promise Health, Quality of Life Improvements

**B**iosystems research in the ME department is on course to improve the health and quality of life of countless patients in the not-too-distant future. Faculty are applying mechanical engineering principles to myriad biological phenomena. And they're working at all levels — molecular, cellular, tissue and organismal.

## Modeling Auditory Processes

Understanding the mechanics of hearing is critical to aiding patients with hearing loss, preventing hearing loss and developing better prosthetic devices.

Professor Karl Grosh has been building mathematical models of the active processes of the cochlea in order to predict the effects of damage and stimulation on the tiny, spiral-shaped structure.

Recently his lab has been modeling processes that provide for the amplification and frequency selectivity that normal-hearing people have. Until his work, scientists have debated precisely where in the cochlea this capability originates — within the outer hair cell body or its stereocilia. “Because the cochlea is so inaccessible, mathematical models are the most effective way to test,” Grosh said. His group has indeed developed a model using hybrid numerical techniques that answers the question. “Our results indicate that the cell body provides sufficient gain to provide amplification for hearing,” he said.

In addition to modeling the cochlea's acoustic response, his group has been modeling the

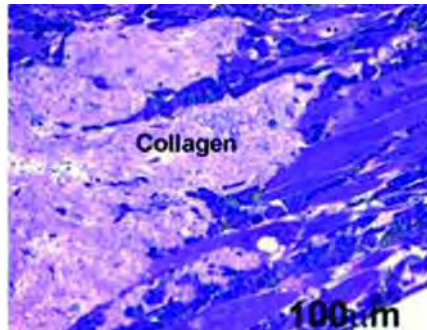

Semi thin sections of in-vitro engineered muscle constructs co-cultured with self-organized engineered tendon constructs. The muscle fibers on the right form an interdigitated interface with the tendon collagen. This engineered myotendinous junction is also biochemically relevant and mechanically viable to strains well in excess of physiological strains.

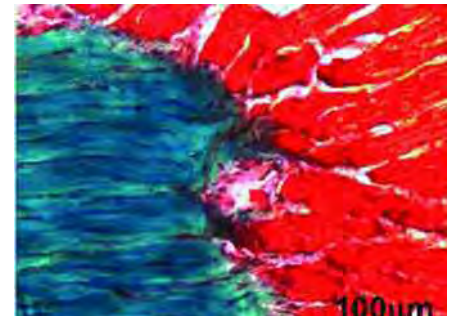

Frozen sections of normal adult myotendinous junction with Mason's Trichrome staining for tendon collagen (blue), skeletal muscle fibers (red), and cell nuclei (black). Note that nuclei (dark staining) of fibroblasts in the tendon (tenocytes) are located in parallel rows flattened between collagen fibers.

outer hair cells specifically. There are some 12,000 of these cells inside the human cochlea, and each cell is about 10 microns in diameter. Researchers in Grosh's lab are modeling the experiments of others with the overall goal of putting them into a larger computational framework that incorporates both molecular- and cell-level biomechanical measurements and parameters. To date, models for the linear, nonlinear and active mechanics of the organ of Corti have been developed, tested and compared with experimental data from *in vivo* test data performed in close collaboration with investigators from Oregon Health Sciences University and the U-M Kresge Hearing Research Institute.

## Engineering Tissue Constructs

In collaboration with Professor Ellen Arruda and Associate Professor Krishna Garikipati, Grosh is studying the growth and remodeling of collagen in soft tissue. The team is using its engineered tendon constructs as *in vitro* experimental models and then building computational models to understand the growth process, particularly the mechanical and chemical influences within the culture environment. The applications of such models are widespread, said Grosh, including cancer cell growth and remodeling of arterial tissue that may result in coronary disease and heart attack.

In collaboration with Lisa Larkin, PhD, research assistant professor with the U-M Institute of Gerontology, and other colleagues, Arruda is engineering tissue constructs with mechanically viable and physiologically relevant interfaces. Recent examples include co-culturing muscle and tendon cells to form a tissue system with a functional myotendinous junction and differentiating bone marrow stromal cells to form either soft (ligament) or hard (bone) tissue and connecting the two tissue types to form a mechanically viable enthesis.

**A cross-section of the cochlea, the active processes of which Professor Karl Grosh builds mathematical models.**

**Inset: The organ of Corti, for which Grosh's group has developed and tested models for organ's linear, nonlinear and active mechanics.**

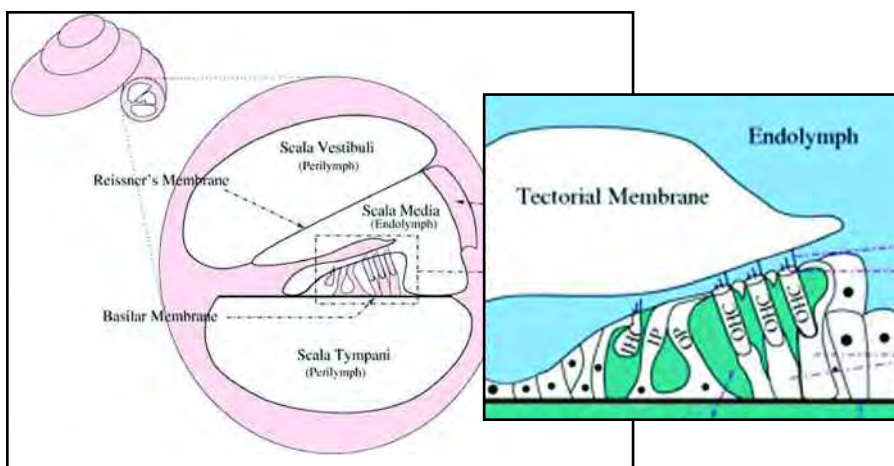



Garikipati is focusing on the development of mathematical and numerical models for growth and remodeling of biological tissue. These models are relevant to understanding normal tissue development, as well as to diseased states, such as cancer. In related work, Garikipati collaborates with experimentalists at the Max Planck Institute in Stuttgart, Germany, on cell mechanics, adhesion and migration.

The group was the first to demonstrate viable animal tendon tissue engineered *in vitro*, without exogenous scaffolding. It is also one of the few research groups worldwide that is developing test systems as well as computational models that will be housed under one roof.

### Tracking Molecular Motors

Associate Professor Edgar M yhofer has been working with colleagues in the U-M Medical School to uncover the mechanical and biophysical properties of individual molecules of kinesin. His goal is to learn more about how the protein behaves inside live cells.

Kinesin is a biomolecular motor and, powered by ATP, it transports cargo inside cells by moving along “tracks” or microtubules. Interestingly, individual kinesin molecules can move faithfully along microtubules without dissociating. M yhofer’s research group is studying these mechanisms through a variety of *in vivo* and *in vitro* methods, including one that hasn’t been successfully employed before: direct observation of individual molecules inside living cells.

Biologists have studied the mechanisms by which kinesin functions in much detail by using purified kinesin and microtubules *in vitro* to determine the structure and characterize the interaction of single motor molecule with microtubules. “Unfortunately” he said, “these approaches

provided little information on how kinesin works in a cell and data from *in vitro* experiments and cell observation are contradictory. Kinesin’s job and how it is regulated in cells have been inaccessible”

M yhofer is looking specifically at kinesin-1, one of many members of the kinesin superfamily. Kinesin-1 plays a key role in nerve cells, where it transports neurotransmitter-containing vesicles to synapses. Each neuron may contain thousands of molecules of kinesin-1.

Using a technique for following individual molecules, M yhofer, along with collaborators Kristen Verhey, assistant professor of Cell and Developmental Biology, and graduate student Dawen Cai, is genetically labeling cellular kinesin motors with a fluorescent tag. He then uses total internal reflection to excite the cell with limited background fluorescence. “This technique was first pioneered by Dan Axelrodt, a former colleague in the Biophysics department, but only combining recent technical and biological advances has allowed us to conduct this pioneering work,” he said. The group has now demonstrated tracking of individual kinesin-1 molecules with 10 ms temporal and ~20 nm spatial resolution.

“Where we want to take this,” he said, “is to understand how transport processes occur in cells....There are a million questions.” Such questions include how kinesin “knows” which “path” to follow — or which microtubules to bind to — within a cell; indirect data suggest that not all microtubules are used with the same frequency. M yhofer also wants to know more about how kinesin interacts with its payload and the scaffolding proteins involved.

In continuing research he also will be looking at individual microtubules and how their chemical (post-translational) modifications modulate interactions with kinesin molecules.

“An obvious technical extension of our work is to detect two fluorescent signals with the same resolution as we can now detect one....It gets more and more exciting.”

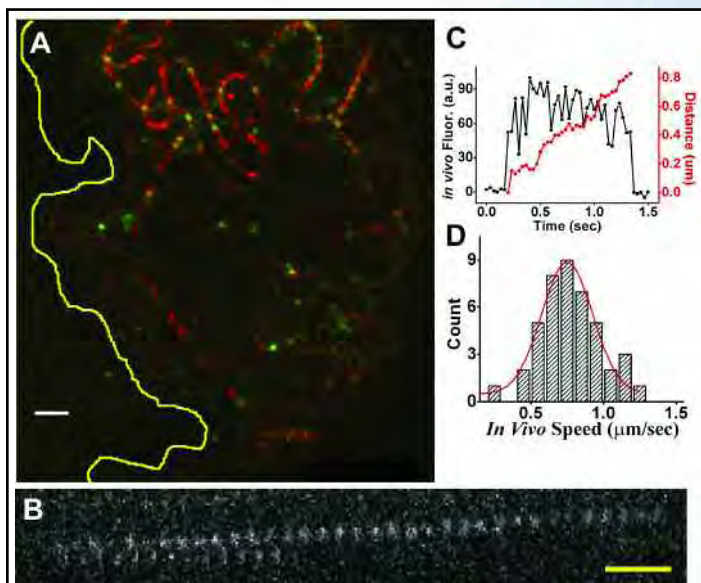

**Tracking single kinesin molecules *in vivo*.** A. Merged TIRFM image and standard deviation map of a COS cells (outlined in yellow) showing individual microtubule tracks and kinesins. B. Kymograph of a single, citrine-labeled kinesin moving processively along a microtubule in a live cell. C. Displacement (red) and fluorescence intensity (black) as a function of time of the fluorescent spot shown in (B). D. Histogram and Gaussian fit of the *in vivo* speed of single kinesins ( $0.78 \pm 0.11 \mu\text{m}/\text{sec}$ ,  $N = 54$ ).

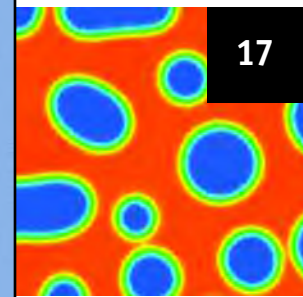



# A Novel Biosensing Platform for Pathogen Detection

In the event of an outbreak of H5N1 avian flu or a bioterrorist attack, public health officials and clinical care providers alike would require a rapid, high-throughput analysis tool to identify multiple biomarkers of infectious agents — appropriate treatment and response would depend on it. Optical spectral detection of fluorescent color signatures holds promise for conducting such multiplexed biological analyses. But current miniature spectrometers have several drawbacks, including limited resolution and the need for a dedicated computational subunit.

Professor Katsuo Kurabayashi has developed an integrated MEMS-based platform that may provide a solution: a novel strain-tunable, high-speed, single-detector spectral measurement photonic device integrated on a single sensor platform. His system would enable high-throughput, multi-analyte detection in flow-through microsphere-based fluoroimmunoassays with simple optics and without a computational subunit.

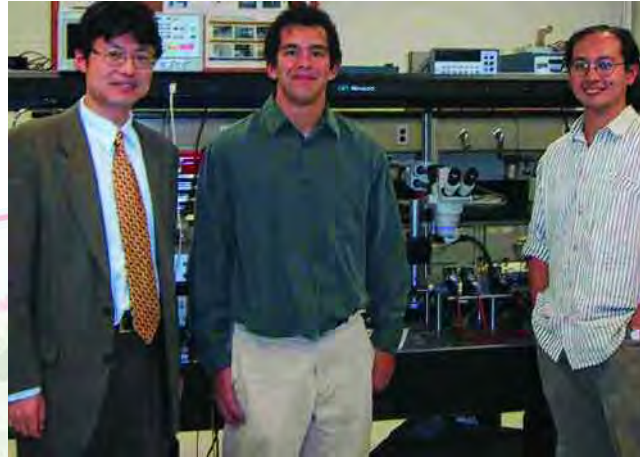

Katsuo Kurabayashi (ME associate professor), Steven Truxal (ME PhD student), and Yi-Chung Tung (former ME PhD student, now BME postdoctoral fellow)

The foundation of his system is a voltage-controlled, strain-tunable nanophotonic diffraction grating device, which his group has recently demonstrated. The grating device is nanopatterned, fabricated from polydimethylsiloxane (PDMS), an elastomer. The grating allows the device to dynamically tune optical wavelengths by repeatedly elongating and shrinking. The elastomer grating is integrated with electrostatic microactuators on a silicon chip.

Since the operator can directly obtain plots of emission spectra by mapping the detected intensity and the voltage-induced strain, computational requirements are significantly reduced. “Our system uses purely mechanical means, which can be easily modeled,” Kurabayashi explained. “You correlate strain with the detected signal to generate a color spectrum map.”

To integrate the system he and his group developed a new polymer-silicon hybrid technology, Multi-Scale Soft Lithographic Lift-off and Grafting. It allows the hierarchical integration of sub-wavelength

polymer photonic structures onto silicon micromachined devices across multi-scale dimensions ranging from a few tens of nanometers to several millimeters. The technique combines polymer soft lithography, nanoimprint lithography and silicon micromachining.

Investigators in Kurabayashi’s lab have recently built a second-generation system with a ten-fold increase in spectrum bandwidth over the prototype. They will be

testing it to validate its performance as a color differentiating device. From there they plan to fully integrate it with a cell-culture microfluidic channel.

The system will allow scientists to detect — and differentiate among — pathogens and other target proteins, such as cancer biomarkers. Multivariable monitoring of living cells and tissue will also be possible. “Hopefully we can get some very interesting information on how these living systems react to pathogens,” said Kurabayashi.

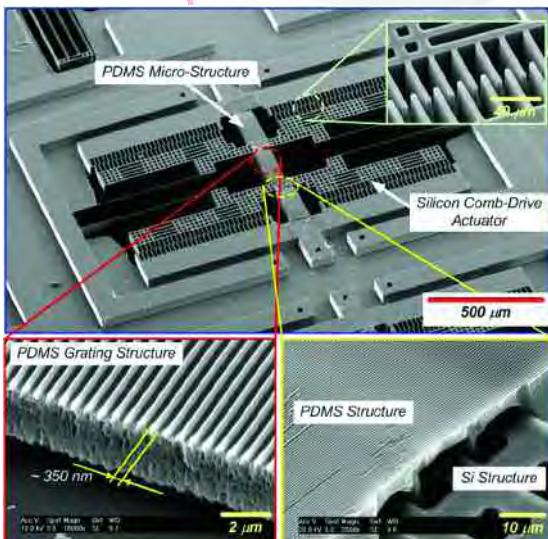

Scanning Electron Microscopy image of the voltage-controlled, strain-tunable nanophotonic diffraction grating device developed by the Kurabayashi Group.

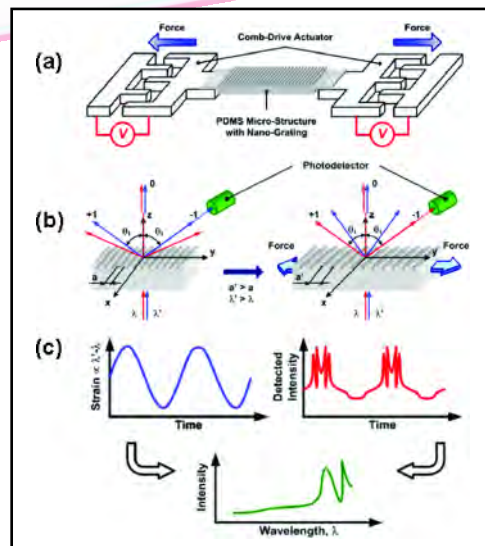

Schematic of Kurabayashi’s strain-tunable nanophotonic device with elastomeric nanostructures integrated. (a) device concept; (b) operational principle; (c) spectrum data acquisition.



# Rapid Prototyping for Advanced Applications in Medicine and Energy

**W**ork being done in the lab of Associate Professor Suman Das may soon improve the lives of many people with a variety of orthopedic, maxillofacial and spinal problems. Researchers in Das' Solid Freeform Fabrication Laboratory are collaborating with Professor Scott Hollister's Scaffold Tissue Engineering Group to develop new manufacturing methods to produce implantable, biocompatible, bioresorbable scaffolds to aid in bone and cartilage regeneration. Using polycaprolactone (PCL), a bioresorbable polymer, they have computationally designed scaffold structures and fabricated them using selective laser sintering (SLS), a rapid prototyping technique. They then seeded the scaffolds with connective tissue cells and growth factors to generate new bone. The work has intermediate term application for repair and reconstruction of human spinal disks as well as the temporomandibular joint (TMJ). Millions of patients suffer from TMJ and disk problems, and many undergo reconstructive surgery. But current treatment methods, including bone grafts from the patient, grafts from a cadaver or titanium implants, all carry serious risks, such as infection, tissue rejection or implant failure. The Das lab's technology would reduce those risks by enabling patient-specific scaffold design and tissue regeneration.

Das is also using SLS of powdered materials for the layer by layer construction of heterogeneous, multifunctional devices. Micro- and nano-scale powders are deposited in prescribed patterns and consolidated to full density. Near-term device applications include not only tissue scaffolds and drug delivery devices, but also solid oxide fuel cells and functionally graded thermoelectric generators for energy production, storage and conversion. The work is part of a

National Science Foundation CAREER Award, which Das received in 2003.

Working with Pravansu Mohanty, an associate professor of mechanical engineering at the U-M Dearborn campus and Brett Lyons, a graduate student pursuing his master's degree in mechanical engineering, Das is also developing hybrid manufacturing techniques for fuel cell components, including metallic bipolar plates. The team uses rapid prototyping techniques combined with thermal spray. The result is the rapid fabrication of components with a high level of geometric complexity at low cost and, therefore, the ability to

investigate novel designs and materials that are currently limited by conventional stamping and machining techniques. The team has demonstrated deposition of molybdenum on aluminium-silicon and fabricated a test bipolar plate comparable to a standard plate used in industry. The prototype was free of defects, with no evidence of corrosion, said Das.

In another NSF-funded project, Das is working with Associate Professor Katsuo Kurabayashi to develop a novel laser nanofabrication process using a near-field optical probe. Their method allows a laser to be focused to a spot with a diameter of less than half of its wavelength.

This method is being applied to maskless, direct-write lithography of advanced materials including polymers for organic optoelectronics.

Das and doctoral student Haseung Chung received the 2005-2006 Robert M. Caddell Memorial Faculty/Graduate Student Research Achievement Award from the Department of Mechanical Engineering. The two were recognized as an outstanding faculty/graduate student team working in the area of materials and/or manufacturing that has made significant research contributions.

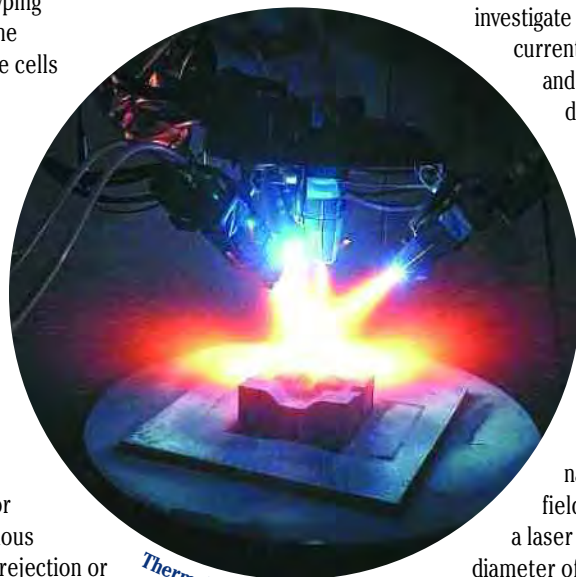

Thermal spray process

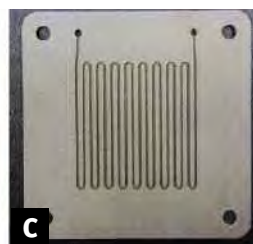
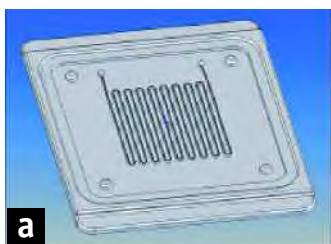

(a) 3D CAD model of bipolar plate pattern; (b) Actual gypsum pattern made by 3D printing; and (c) Actual bipolar plate produced by thermal spray deposition of graded multilayers of Ni-Al and Molybdenum.

# Large Advances in Small Technology

Faculty in the ME department are turning the promise, power and potential of nanotechnology into reality through their endeavors. From conceiving of, synthesizing and characterizing novel materials to refining micro- and nanofabrication processes, their creative and innovative research programs span disciplines and break conventional boundaries.

## Energy harvesting textiles, intrachip communications and next-generation coolants

Assistant Professor Kevin Pipe has undertaken three new projects in his lab. In a project funded by the U.S. Air Force, fiber-shaped thermoelectric and photovoltaic devices are woven into energy-harvesting textiles for aerospace composites, allowing the conversion of thermal and solar energy to power on-board aircraft devices.

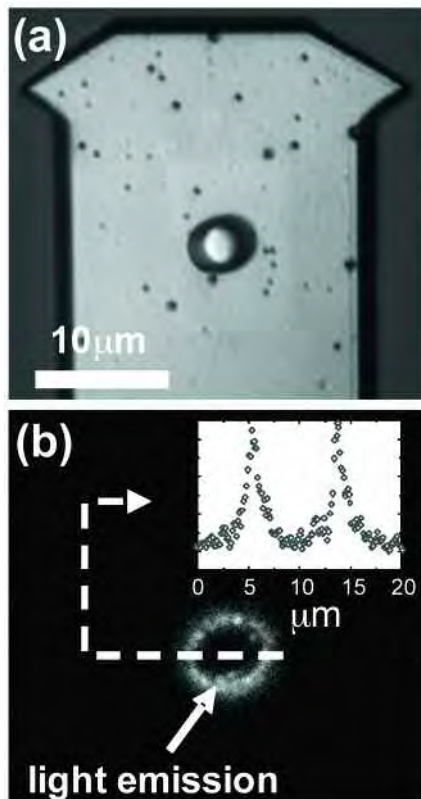

a) Optical image and b) light output of a microscale optical microscopy tool developed by Pipe and Shtein (UM MSE Dept.) which is formed by fabricating an organic LED on a scanning probe cantilever [Appl. Phys. Lett. 89, 111117 (2006)].

Collaborators include Assistant Professor Max Shtein in Materials Science and Engineering, Professor Tony Waas in Aerospace Engineering, and Assistant Professor Peter Peumans in Electrical Engineering at Stanford University.

In a National Science Foundation-funded project, also in collaboration with Shtein, Pipe is using organic electronics to develop a new scheme for intrachip communications for integrated circuits. The basis of the scheme is plasmonic waveguides, which offer small size and high bit rate. The signals in these waveguides degrade quickly, however, making amplification necessary. In order to create signal gain, Pipe and Shtein are using novel structures based on organic semiconductor heterostructures.

In response to the problem of heat generation by fuel cell and hydrogen technologies, Pipe recently received a two-year General Motors Discovery grant in collaboration with Professor Albert Shih to develop next-generation nanofluid-based coolants for vehicles. The project includes characterizing the thermal and electrical properties of suspensions of aluminum oxide nanoparticles, carbon nanotubes and other nanomaterials.

## Novel nanomaterials for gas sensing

Associate Professor Margaret Wooldridge and her graduate students Tiffany Miller (PhD '05), Smitesh Bakrania, and Carlos Perez have developed a unique approach for combustion synthesis of nanosized particles, including nanocomposites, using a hybrid diffusion flame system. "Our methods represent an original and exciting new avenue of research, where we can control the particle composition and microstructure by varying the relative physical and chemical reaction rates important in the combustion synthesis environment," explained Wooldridge. Specifically, her group is working on a NSF-funded project to develop novel tin dioxide (SnO<sub>2</sub>) nanomaterials for semiconductor gas sensors. The challenges that limit progress in the development of SnO<sub>2</sub> gas sensors include difficulty integrating additives (which can significantly augment sensor performance),

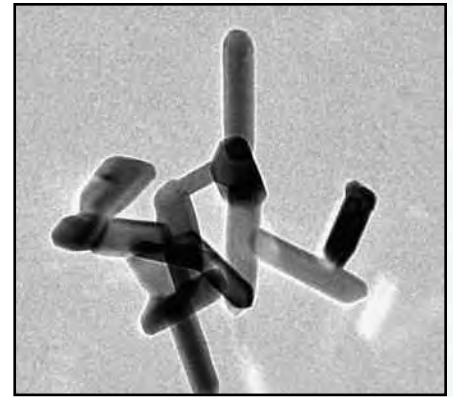

SnO<sub>2</sub> nanorods created by Wooldridge group using flame synthesis.

developing commercial scale production rates, eliminating impurities associated with fabrication and understanding the effects of additives on SnO<sub>2</sub> sensor performance. "Combustion synthesis can address many of these limitations," said Wooldridge. "We have demonstrated a single step solvent-free process to create SnO<sub>2</sub> nanoparticles. This method greatly expands the range of control possible over SnO<sub>2</sub> structure, including the synthesis of nanorod and core/mantle type structures." These structures can have significant implications with respect to improving gas sensor performance.

## Optical refrigeration with rare earth nanopowders

Although almost any material can be heated by a laser, rare earth ion-doped solids are the only materials that have been proven experimentally to be cooled by lasers. The highest cooling efficiency ever achieved in bulk materials is about two percent, but using ion-doped nanopowders, Professor Massoud Kaviani's research group has found that cooling can be enhanced by more than 200 percent, to less than 150 degrees Celsius.

The significant results were achieved by determining the optimal dopant concentration using energy transfer theory, by facilitating a larger photon-electron-phonon interaction rate, and by photon localization in the random powders, resulting in enhanced absorption of the incident beam. The group's findings can also be applied to bulk materials and have implications for enhancing countless



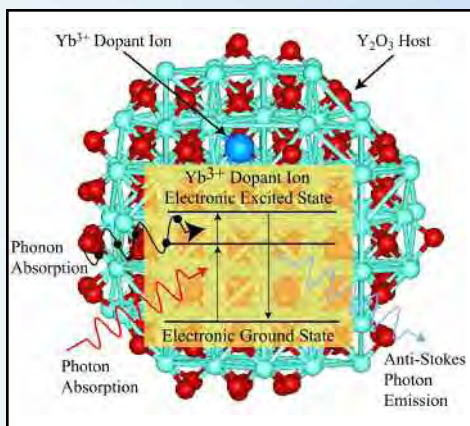

applications, from atomic clocks to medical devices.

Kaviany presented the work in October 2005 at Purdue University as part of its Hawkins Memorial Lecture Series in Heat Transfer.

### Uncovering mysteries of self-assembly for nanofabrication

Advancing technologies demand solid structures of ever-decreasing length scales, and the critical challenge is how to mass produce nanoscale structures economically. According to Assistant Professor Wei Lu, nanoscale self-assembly is a promising low-cost, high-throughput solution to many problems in nanotechnology. However it has only been observed in limited number of material systems to date, and resulting structures often suffer from nonuniformity and lack of size and position control. The work of his research group aims to develop innovative methods and design tools to control self-assembly processes by manipulation of field design and systematically develop diverse material systems for nanofabrication.

Lu and his students have uncovered the self-assembly mechanism in various materials systems and developed advanced computational tools to simulate the processes. In a recent paper in

*Physical Review Letters* Lu demonstrated the possibility of patterning multilayers of molecules via molecular dipoles. This work established a quantitative expression and effective approach to account for the interactive energy of molecular dipoles in multi-layers and established the knowledge and design tools to tune the size and ordering of molecular domains. The research suggests a novel self-assembly approach to pattern molecules into designed nanostructures, which have wide applications from organic electronic devices, sensors, to fuel cell membranes for energy applications.

The work has led to the novel concept of nanotechnology lubrication, where mobile molecular lubricants are directed to the contact surfaces with external electric field to form optimized configurations. Lu is collaborating with the Air Force Research Laboratory to study lubrication in nano and micro mechanical contacts and correlate the lubrication mechanisms to molecular structures. The work will significantly advance the operation condition and performance of MEMS devices.

Lu and his group have also investigated the stability of polymer-air interface and electric field processing of thin films. And they have developed the first three-dimensional dynamic model that incorporates viscous flow, diffusion and dielectric mechanisms. The work on the effects of surface stress, applied strain field and surface chemistry on molding nanostructures in monolayers paves the way for fabrication of uniform quantum dots and other nanostructures.

Lu, with doctoral student David Salac, earned the 2006 Caddell Memorial Award for excellence in research. He is the 2005 and 2006 Air Force Summer Faculty Fellow. His other awards include the NSF CAREER Award and the Robert J. McGrattan Literature Award by the American Society of Mechanical Engineers.

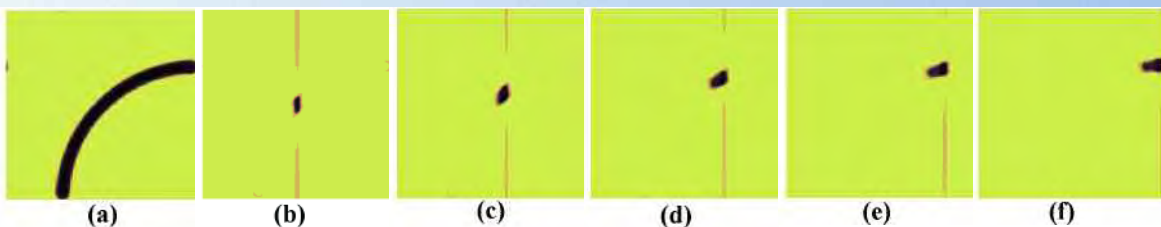

Travel of a molecular vehicle along the track in (a)

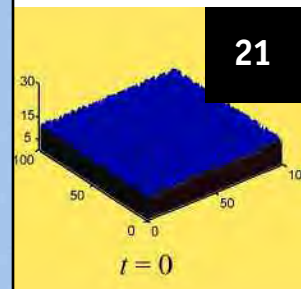

Nanoscale self-assembly:  
Electric field induces surface instability, causing nanopillars to grow out of the film surface.

research

# Nano-Scale Combustion Science

Assistant Professor Angela Violi, who joined the ME faculty in January 2006, has already established a strong program in theoretical nano-science, with the goal of her research to chemically and physically characterize organic pollutants of high molecular mass and to study their fate in the environment. Toward that end she has created a novel multiscale computer simulation approach.

Size, chemical functionalities and water solubility all determine the properties of aerosols. The same parameters establish their optical properties relevant to direct radiative forcing in the atmosphere and to their ability to act as cloud condensation nuclei. Violi uses multiscale methods, such as the kinetic Monte Carlo technique combined with molecular dynamics, to follow nanoparticle formation and growth in a chemically specific way. This approach provides a connection between the various time scales in the nanoparticle growth and self-assembly problem as well as an unprecedented opportunity to understand the atomistic interactions underlying nanoparticle structures and growth.



In a project funded by the National Science Foundation, Violi is studying the problems associated with the emission of carbonaceous nanoparticles from diesels. In particular, she is looking at the processes that govern the development of the absorbing properties of nanoparticles and soot and the processes occurring between the engine exhaust valve through the exhaust plume that have been shown to be a major contributor to the

formation of and human exposure to nanoparticles.

In another NSF-funded project, she is investigating the formation of nanoparticles in combustion systems, "A fascinating multiscale problem," she said, involving both molecular science and the statistical mechanics of nonequilibrium self-assembly and nucleation over two disparate length and time scales. Violi is developing new computational methodologies based on novel coarse-graining molecular dynamics techniques. This approach bridges the length and time scales in the area of nanocluster self-assembly. It will contribute to the better understanding of nanoparticle self-assembly, a topic of great interest to many researchers.

Through Air Force Office of Scientific Research funding, Violi is developing new fuel breakdown mechanisms by identifying new reaction pathways for real fuels in order to produce a complete description of the system under investigation. Using a combination of molecular dynamics and *ab initio* techniques, she will examine intermediates, products, kinetics, thermochemical and transport properties.

Her work also looks at the biomedical impact of nanoparticles by gaining a detailed biophysical understanding of the long-term interactions of these particles with self-assembled biological structures, such as cell membranes. "Learning how nanoparticles penetrate and modify the structural, thermodynamic, dynamical and mechanical properties of these biomolecular systems will help us comprehend their potentially harmful effects and develop methods for their remediation" she said.

Violi has joint appointments in the Department of Biomedical Engineering and Chemical Engineering.

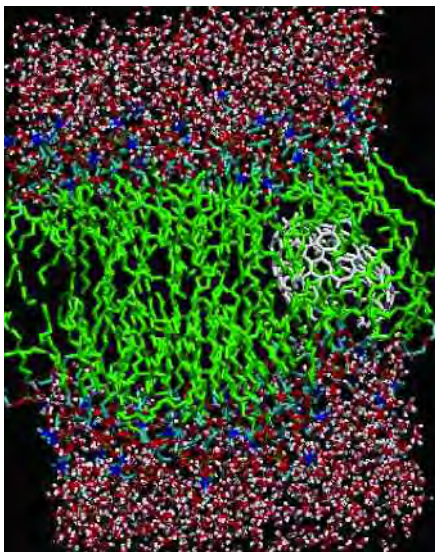

**Molecular dynamics simulations of nanoparticles in lipid bilayers.** (S. Izvekov, A. Violi "A Coarse-Grained Molecular Dynamics Study of Carbon Nanoparticle Aggregation", *J. Chem. Theory Comput.* 2(3), 504-512 (2006))

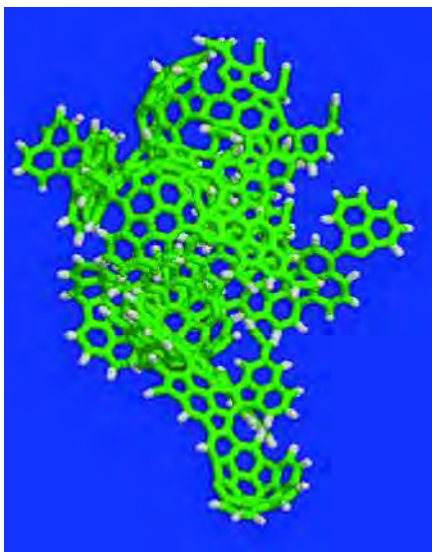

**Carbonaceous nanoparticles produced through the proprietary Atomistic Model for Particle Inception code.** (A. Violi, "Modeling of Soot Particle Inception in Aromatic and Aliphatic Premixed Flames," *Combustion and Flame* 139: 279-287 (2004))



# Hong Im Joins Effort to Form New Collaborative Center

With the efforts of U-M colleagues including ME Associate Professor Hong Im and faculty members at Michigan State University, the U-M College of Engineering will be home to a new center: the Michigan/Air Force Research Laboratory Collaborative Center in Aeronautical Sciences.



The center, MACCAS, will draw upon the expertise in computational aeronautical sciences throughout Michigan. "This will provide many new opportunities for future research efforts in aeronautical and aerospace applications of interest to the Air Force Research Laboratory," said Im.

The team submitted its proposal for the center early in 2006 and was selected through a competitive process.

The center's initial focus will be developing and integrating the computational tools required to perform reliable, high-fidelity, multi-disciplinary analysis of airbreathing, hypersonic

vehicle concepts. The center will also support the AFRL's interest in fine-scale, unsteady fluid dynamics.

The investigators will establish a center that is recognized internationally for excellence in aeronautical sciences research and education through strong collaboration among faculty and students from both universities and the AFRL. Team members bring tremendous theoretical, computational, experimental and simulation capabilities to the center; they also have a long history of successful collaborative work with the AFRL, industry and federal agencies.

Im will be working in the area of high-fidelity combustion and reacting flow model development. Other MACCAS co-investigators include U-M Aerospace Engineering faculty members Professor Wei Shyy, who is the principal investigator, along with professors Iain Boyd, Werner Dahm, Peretz Friedmann, Ken Powell, Phil Roe, Bram van Leer and Associate Professor Carlos Cesnik.

Co-investigators from Michigan State University include associate professors Giles Brereton, Farhad Jaber and Mei Zhuang, all of the Department of Mechanical Engineering.

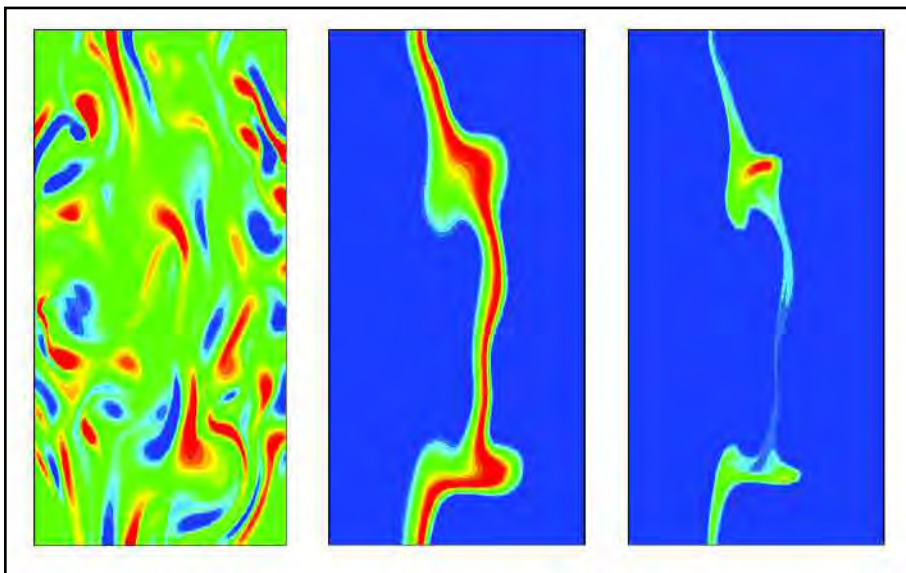
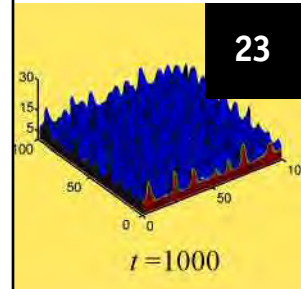

Simulations of turbulent non-premixed ethylene-air flames showing, from left to right, vorticity, temperature and soot volume fraction.

# Furthering Fuel Cell Technology

Fuel cells hold much promise as an alternative source of energy, particularly for portable power generation. These systems offer several advantages, including low emissions, scalability, fuel flexibility and high efficiency. Yet there are challenges to their adoption that must be overcome. And not surprisingly, U-M researchers are developing solutions.

## Addressing Control Issues

Professor Huei Peng's interest in fuel cells was piqued six years ago through his work in vehicle dynamics control. "There are a lot of



From left: Denise McKay, Antonio Reis and Anna Stefanopoulou conducting work on dynamics and estimation.

very interesting control issues for fuel cell systems, including power tracking and water management," he said. Proper humidity control is critical for proton transport across the membrane in Proton Exchange Membrane (PEM) fuel cells, but sensors to monitor humidity levels don't work reliably in oversaturated conditions.

So Peng is conducting both experimental and analytical studies related to water generation and transport phenomena inside a single-cell fuel cell. He is using embedded, miniature relative humidity sensors to provide experimental data on the distribution of water. Using neutron radiography at the National Institute of Standards and Technology Center for Neutron Research and subsequent photo masking techniques, Peng is able to measure water distribution accurately.

He is building a two-dimensional fuel cell model using the data obtained. The active area is modeled as 15 segments, which allows the distribution of current, water and relative humidity to be investigated more accurately, he explained. Six sub-models characterize the fuel cell cathode/anode channel, cathode/anode gas diffusion layer, membrane hydration and voltage. The work is ongoing. "Once we get a good model we will use it for optimizing channel design as well as for the control of external humidifiers and overall water management."

## Dynamics and Estimation

Professor Anna Stefanopoulou co-directs the Fuel Cell Control Systems Laboratory with Peng, and her work on the technology focuses on low level control issues such as thermal and water management of fuel cell and fuel processing systems for fast and robust reactant delivery, warm-up and high level design decisions, such as sizing and optimum power split between a fuel cell and an energy storage device. She presented the keynote lecture for the American Society of Mechanical Engineers Third International Conference on Fuel Cell Science, Engineering and Technology. She also presented several workshops on the control of fuel cell systems, including sessions sponsored by the American Automatic Control Council at the 2006 American Control Conference and by The MathWorks, a technical software provider.

Stefanopoulou is the principal investigator of a new, three-year National Science Foundation grant for the "Estimation and

Control of Water in PEM Fuel Cells." She was selected as the 2005 Outstanding Young Investigator by the ASME International Dynamic Systems and Control Division.

## Fuel Cell Manufacturing

"Manufacturing is a major area to be addressed in order for us to see widespread adoption of fuel cells," said Professor Albert Shih. That's because of the high costs to produce them today. Working with ME professors Jack Hu, Jun Ni and post-doctoral researcher Gap Kim, graduate student Yuanyuan Zhou and Chemical Engineering Professor Levi Thompson, the U-M manufacturing faculty are looking at fuel processor design, component manufacturing and stack assembly that will ultimately decrease the costs of production.

Yuanyuan Zhou, who is co-advised by Hu and Shih, has developed models and is conducting experiments on the impact of assembly process on the electrical contact resistance, gas and water transport and mechanical deformation in stack assembly that will lead to insights into the durability and performance of the PEM fuel cell stack. The research group is working with ITRI, a Taiwanese government R&D organization, on the project. A one kilowatt fuel test stand has been provided by ITRI for testing and evaluation of the fuel cell manufacturing technology.

In addition, an undergraduate student team has designed and built a novel hydraulic stack pre-load actuation to evenly distribute the clamping force and reduce the local deformation and stress concentration.

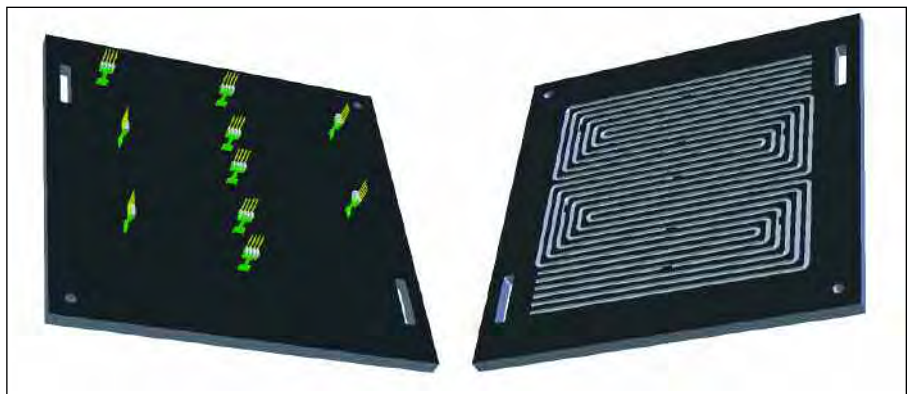

A graphite plate embedded with relative humidity sensors.



# From Cells to Cars, the Heterogeneous Multiscale Materials Lab Looks at Power

Ask what a single cell and a new hybrid electric car have in common, and the answer might be the Heterogeneous Multiscale Materials Laboratory. One focus of the lab, directed by Professor Ann Marie Sastry, is the investigation of energy-related phenomena, be they at the cellular or macro level. The lab's work spans several fields, including biology, energy, nanoscale science and applied mathematics. "Understanding fundamental material behavior gives you wonderful entre into many different areas," Sastry said.

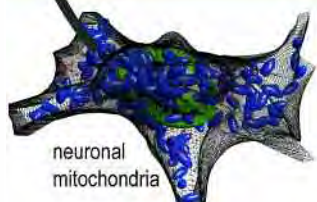
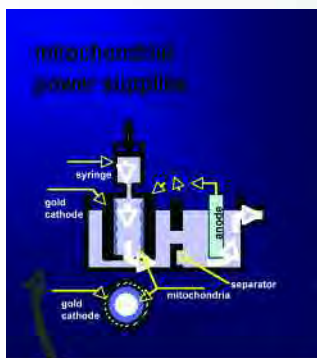

**By studying cells' own power plants, mitochondria, Sastry is exploring bio-based power supplies.**

output of a cellular mitochondrion, the organelle that produces energy within a cell, and mitochondrial arrays. The project, part of a program on Biophysical Mechanisms led by Major Jennifer Gresham, is aimed at discovery of new power sources. "The great unknown is what the actual capacity of a mitochondrion is," she said. "Because energy science is at the forefront of the public mind right now, there's a lot of prognostication going on. But as researchers, it is incumbent upon us to sort through the options in a technically rigorous way."

Indeed the capacity of the fundamental power plant in cells, mitochondria, had been unexamined until Sastry's group

began such work. The power output, rate effects and cluster properties of these organelles, which undergo fission and fusion in response to physiological conditions, are all critically important in determining what the ultimate power generation might be for biofuels. Researchers in her lab, and that of her collaborator, Professor Martin Philbert in the U-M School of Public Health, developed ways to not only mathematically characterize clusters of mitochondria but to use electrochemical testing to sense the available capacity of mitochondrial arrays. The work has potential to contribute to further mapping of the energetics of mitochondria for evaluation as a renewable source of power, particularly for wireless devices.

In an alliance with Ford Motor Company, with the Ford team led by Ted Miller and Kent Snyder, Sastry and her group are using their knowledge of particulate architectures and single particle behavior to design new materials for power packs. The work extends an 11-year project that has been continuously funded by the U.S. Department of Energy. "What's very exciting is that those who make and use batteries now agree this scale of computation and fundamental science can provide real performance breakthroughs. And, working directly with Ford gives us the insight we need into manufacturing and cost issues so critical to adoption of new technologies."

Those breakthroughs include simulations of how sub-micron particles behave in a battery, a departure from the conventional approach of simulating the entire system. Given the surging interest in clean energy technologies for vehicles, many materials are now being examined for their use in batteries. "The bottleneck now," Sastry said, "is in synthesizing the different blends of materials into a high performance cell."

"It's literally impossible to develop prototyping capabilities that will allow you to experimentally look at all the options, so advanced computation is absolutely critical in picking the winners and bringing high-performance technology to vehicles as fast as possible." Her lab has undertaken electrochemical modeling of lithium-ion systems. Through its work, she said, "We're helping Ford pick the winners."

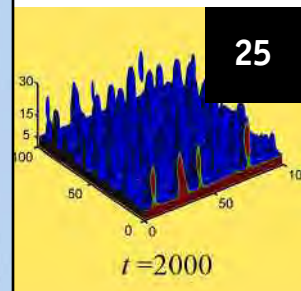

research

# Large Scale Friction Drag Experimentation

There has been renewed interest among the U.S. Department of Defense and other agencies in recent years in high-speed ocean transport. But as speed increases, so does resistance. Doubling a cargo ship's speed increases its power requirement by a factor of eight, explained Professor Steven Ceccio. "That's the motivation behind our research, to understand and reduce friction drag at high Reynolds numbers."

Ceccio works with ME Professors David Dowling and William Schultz; Professor Marc Perlin of Naval Architecture and Marine Engineering; Associate Professor Michael Solomon of Chemical Engineering and Professor Wei Shyy of Aerospace Engineering. The U-M team collaborates with computational teams at Stanford University, General Dynamics Corporation and Pennsylvania State University. The computational teams have developed numerous modeling and simulation tools to predict flows, explained Ceccio. The U-M group conducts large scale experiments to validate these tools. DARPA and the Office of Naval Research have been funding the work.

The two methods of drag reduction being investigated include the injection of gases and polymers close to the ship's hull. Much of the research takes place at the Navy's William B. Morgan Large Cavitation Channel, the world's largest water flow facility.

Such large-scale experiments are necessary to understand "the richness of the physics," explained Ceccio. "For gas and bubble injection, the simple scaling rules that have been successful in conventional designs are not adequate." To simulate the flows around the hull of a ship, researchers use a flat plate, 3.05 meters wide by 12.8 meters long by .18 meters thick, with an elliptical leading edge and a tapered tail.

Using instruments developed at U-M including micro-particle image velocimetry and planar laser induced fluorescence techniques, the team measures flow velocity, skin friction, surface pressure and plate acceleration measurements at multiple downstream locations to cover a Reynolds number range from 1 million to more than 200 million. The higher the Reynolds number, the



**Outside view of the William B. Morgan Large Cavitation Channel (LCC). To assess the size of the facility, note the people at the right and left edges of the photograph.**

thinner the boundary layer becomes. On the test plate, "all the interesting flow physics occur within 100 microns of the plate surface," he said. The group has been able to measure and explain the persistence of the effects of both gas and polymer injection. In addition to quantifying the polymer-turbulence transport, the investigators have observed molecular degradation caused by near-wall turbulence under different conditions.

The most recent set of experiments have looked at the effect of surface roughness on these drag reduction technologies. From here, the Navy may commission at-sea experiments.

"If these technologies prove efficient," said Ceccio, not only will they speed travel time, but "they will open up the design envelope for ships."

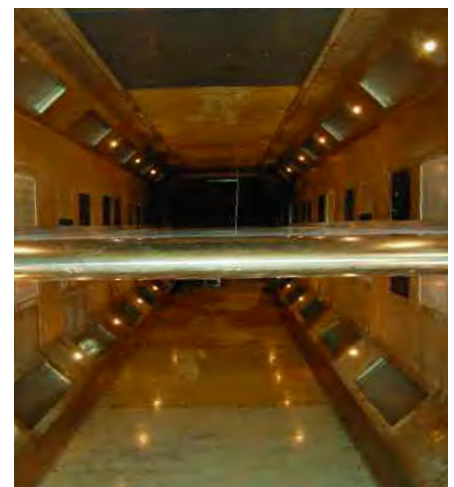

**Inside the LCC's test section (drained), looking aft from the leading edge of the flat-plate test model. The side-to-side and floor-to-ceiling distances are both 10 feet. When a test is underway, water flows from behind the observer, over or under the test model, and then into the dark area in the center of the picture.**



# Dowling, Schultz Develop Washing Machine Simulations

Doing the laundry has taken on a whole new spin for a team of ME researchers. Professors David Dowling and William Schultz are co-principal investigators of a five-year, \$500,000 research project sponsored by Whirlpool Corporation. Their objective: To develop physics-based simulations of what happens inside a washing machine so that the company can more efficiently evaluate new designs.

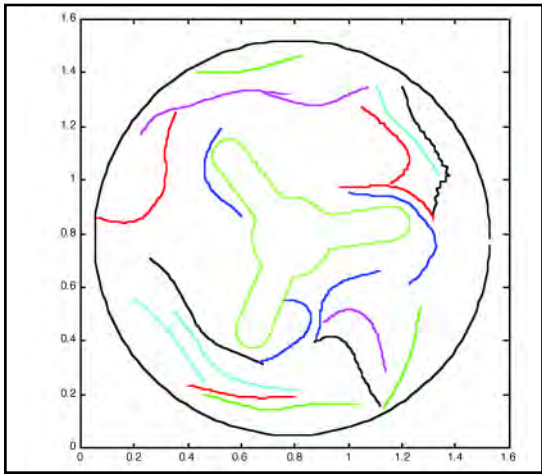

Top image: A two-dimensional simulation of fluid-structure (cloth-water) interaction.

Center image: A CAD rendering of the agitator or “wash plate” of a washing machine from Whirlpool.

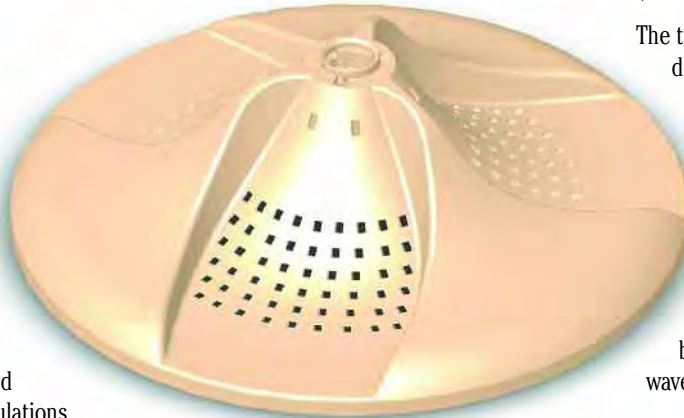

Doctoral candidate Deniz Akcabay is working with Dowling and Schultz, both specialists in fluid dynamics and mechanics, to develop the simulations.

More than 80 million U.S. homes have washing machines, which use about 40 gallons of water per load — 15,000 gallons per year per typical household. That’s several hundred pounds of water to wash a 10- to 15-pound load of laundry. Manufacturers are designing new appliances with an eye toward water — and energy — conservation, but less water means clothes take more of a beating in order to get clean. As a result, they may wear out faster. Design parameters have to change to compensate for the effects of water reduction.

The simulation software the team is currently developing involves a “highly deformable flexible solid (cloth) and a lot of water, an ordinary and common fluid,” explained Dowling. Whirlpool engineers have told the research group that if they can reliably predict how cloth moves inside the washtub, they can evaluate washing effectiveness. The more cloth cycles from the top of the tub to the bottom in a top-loading machine, for example, the better; cloth trapped in a corner won’t get as clean.

For the first two years of the project, said Dowling, the team worked in two dimensions. Recently the group advanced to working in three dimensions, which are “computationally and algorithmically more burdensome, but at the same time so much more interesting and realistic,” he said.

The researchers have simulated multiple pieces of cloth in fluid interacting with a complex three-dimensional washer geometry. “The model at this stage assumes a fixed liquid level, impermeable cloth and a relatively low Reynolds number,” explained Akcabay. The motion of cloth and fluid are coupled, and the cloth has both membrane and bending stiffness. “We recently began benchmarking our individual cloth and fluid models with results in the literature,” he added.

The team is simulating more densely packed wash-tubs since consumers tend to overfill their machines. Future work includes simulating front-loading machines by changing the axis of rotation and adding bubbles and surface waves to the simulation.

The U-M team has worked closely with engineers at Whirlpool. By the end of the project, the team will deliver software that company engineers can then use to model various design parameters, such as differently shaped tubs and agitators, and agitator rotational speed and direction, among others. Dowling expects that the company also may also be able to use the software to simulate the movement of air and cloth inside clothes dryers. Such simulation tools should reduce the number of prototype machines Whirlpool engineers build and test. “We expect the software we deliver will save the company a lot of money in the long run,” Dowling said.

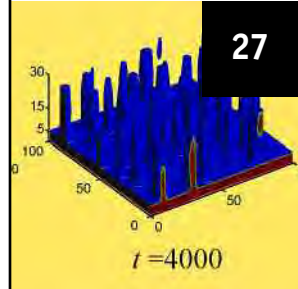

research

# Environmental Policy, Auto Design and Materials Flows Project Finds Its MUSES

Passenger cars and light trucks have accounted for about one-fifth of U.S. greenhouse gas (GHG) emissions since 1990. Demand for these vehicles is also the source of materials flows that are among the largest known to modern society. As lawmakers consider public policies to address these issues, they have few if any scientific tools with which to predict the outcomes of proposed policies, including the unintended consequences on materials flows and environmental emissions over the automobile life cycle.

Associate Professor Steven Skerlos and colleagues at several universities have received a National Science Foundation grant to develop modeling tools and methods that will change all that. The five-year, \$1.9 million grant was awarded under the NSF Materials Use: Science, Engineering and Society (MUSES) program and builds on a \$100,000 seed grant the team received in 2005.

There are plenty of reasons to be concerned with the effects of GHG emissions-reduction policies on material flows, according to Skerlos: over one-third of U.S. utilization of iron, lead, platinum and rubber goes into automotive production; approximately one-fourth of the 30 million tons of worldwide aluminum production is for new vehicle production; about 15 percent of the 100 million tons of iron and steel shipped in North America in 2004 went to the automotive industry; and annual production of cars accounts for some 10 percent of copper and 23 percent of magnesium production.

But while there are technologies available that can lower vehicle GHG emissions, understanding and balancing producer cost and consumer preference and behavior is a challenge. For instance, if you implement a hybrid electric drivetrain for fuel economy, asks Skerlos, how will consumers change their driving behavior once they realize that their cost to drive per mile is reduced? If automakers make lighter vehicles in response to government policy, what is the effect on GHG emissions from increased aluminum production? Right now, "there's a lot of confusing and argumentative debate going on," said Skerlos. "It's very subjective. Being

engineers from academia, we can bring to the table quantitative analysis and objectivity."

Skerlos is co-director of the team of nine investigators with James J. Winebrake, chair of the Public Policy Program at Rochester Institute of Technology. Other collaborators include Gregory Keoleian, co-director of the Center for Sustainable Systems in the U-M School of Natural Resources; Walter McManus, director of U-M's Office for the Study of Automotive Transportation; ME Professor Panos Papalambros; and faculty from RIT, University of California, Davis and Berkeley, and Northeastern University.

The project's three thrust areas include policy analysis and optimization; producer and consumer models; and technology and environmental performance. An external advisory board comprised of transportation and environmental experts from industry, government and the not-for-profit sector as well as an international review board will provide insight and support.

To achieve their goals, student and faculty researchers will develop a game theoretic meta-systems model of the automotive industry and mathematical analysis methods to understand the relationships between

market interventions and Nash equilibrium engineering designs. They will apply optimal control theory methods to the design of public policy instruments and create novel life cycle assessment methods that are predictive and dynamic.

Models do exist that explore the effects of GHG emissions from the automotive industry, but this MUSES project will be the first to explicitly and systematically explore the space of nominally overlooked dynamics of markets, material flows and environmental emissions as they are impacted by government policy instruments.

"Marketing researchers have developed models of market dynamics but not of technology performance. Technology researchers have developed models of technology performance but not of market dynamics. There aren't a lot of 'bilingual' studies," Skerlos said. "That's where our work is different. We'll be able to look at both and predict the outcomes to learn which policies actually accomplish the mission of reducing GHG emissions with minimum impact on consumer preferences and corporate profitability."

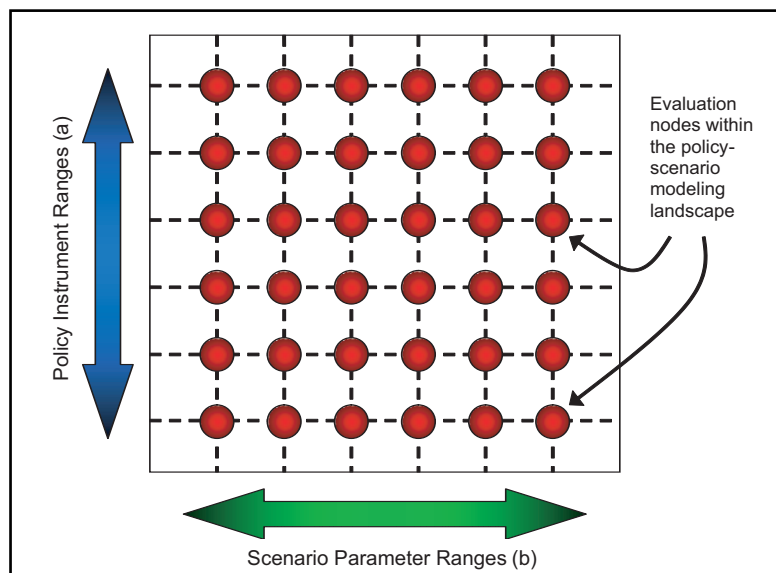

Scenario Matrix managed by a Computer-Aided Scenario Generator.

For more information, visit the project website:  
<http://sitemaker.umich.edu/autopolicydesign>



# Low Temperature Combustion Consortium for Ultra-Clean Engines

**A** U-M-led multi-university consortium to investigate low temperature combustion (LTC) engines for automotive applications has received a three-year, \$5 million award from the U.S. Department of Energy. The consortium also includes the Massachusetts Institute of Technology, University of California at Berkeley, and Stanford University.

The LTC concept promises 20 to 25 percent improved efficiency and ultra-low nitrogen oxides (NOx) and particulate emissions. Like gasoline engines it employs a relatively uniform mixture of fuel and air to reduce soot and particulates; like diesel engines it utilizes a high compression ratio to improve thermodynamic efficiency.

There remain significant hurdles to the implementation of HCCI in automobiles. Current experimental work indicates that HCCI combustion can only be maintained in part of the required speed and load range of a typical engine. When loads are too high, the combustion is harsh and knock is objectionable; when loads are too low, combustion is unstable and misfires occur. The consortium is working to extend the operating range of HCCI, through both experimental work on full-metal and optical engines, as well as by simulation with detailed engine system models.

Because combustion is initiated by autoignition, the temperature of the air-fuel mixture is critical. Work at U-M in a single-cylinder HCCI engine has revealed that internal wall temperature also has a strong effect on stable ignition. Wall temperatures vary continuously throughout normal driving

patterns, and results of modeling work done at U-M indicate that controlling wall temperature through precision cooling and adjusting residual gas could significantly extend both low and high operating ranges.

Consortium investigators are also exploring the use of turbo- or super charging in order to pack more fuel and air into the cylinder and obtain a higher load at low combustion temperatures; regenerative heating; and direct fuel injection. U M researchers are modeling these systems, supporting the experimental work done at partner institutions.

Consortium researchers are also turning their attention to the LTC characteristics of reformed gasoline fuels, renewable fuels and blends of conventional fuels with reformed and pretreatment strategies for use in advanced engines. This work is being carried out at U-M in a Rapid Compression Facility and in a newly acquired optical engine test setup (see related story below). High-speed images of the combustion event have been captured, showing that under some conditions combustion can be influenced by a spark even though a flame is not observed. This suggests that some form of combustion assist may be possible under low temperature and low load conditions.

“I’m hopeful,” said Assanis, “that it won’t be long before we see a viable implementation of the HCCI concept in U.S. automobiles.”

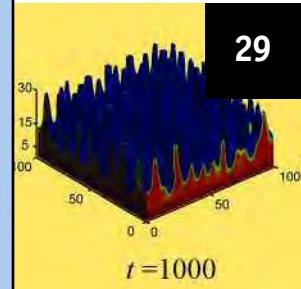

An evolution sequence for a relatively thick film. The film continues to evolve after touching the ceiling, leading to significant coarsening. This changes the pillar structure into interwoven stripe structure.

## Optical Engine Yields Insights

**A**ssociate Professor Margaret Wooldridge and her Combustion Laboratory group have created a new research engine facility to study strategies to improve internal combustion (IC) engine efficiencies and improve engine performance for next generation fuels, including high energy density fuels derived from alternative fuel stocks such as biorenewable and synthetic crude oils. Ford Motor Company donated the single-cylinder research engine, equipped with optical access, to initiate the project. Using the new engine Wooldridge’s research group, led by graduate student Bradley Zigler, set out to characterize ignition phenomena during homogenous charge compression ignition (HCCI) operating conditions.

HCCI engines present considerable opportunity for efficiency and emission gains. However, they also present challenges, which have limited the domain where HCCI operating modes are feasible. The studies at U-M explore the effects of spark assist (SA) as a means to expand the HCCI operating regime. High-speed imaging of the in-cylinder volume yielded direct, time-resolved data on key ignition and reaction phenomena occurring during HCCI operation. SA was shown to stabilize HCCI combustion, which means it indeed has the potential to extend lean operating limits. “These images are the first of their kind, and our analysis allows us to understand why spark assist augments HCCI performance,” said Wooldridge, “and how we might be able to do better.”

research

# Automotive Research Center Advances Vehicle Modeling Technology

The Automotive Research Center, a U.S. Army Center of Excellence, continued its rapid progress toward its overarching goal, namely, advancing technology for high fidelity simulation of military and civilian ground vehicles. The Center's mission is to develop and demonstrate flexible, agile simulation systems to significantly improve the product development process of military and commercial automotive manufacturers. Such improvements include those in the areas of fuel economy, safety, durability and human factors, and were highlighted at the 12th Annual ARC Conference.

Energy for transportation and efficient propulsion technologies are addressed with modeling and simulation of several new powertrain concepts for the dual-use HMMWV/Hummer platform. Energy conversion and storage options for hybrid vehicles were first explored through simulation studies. For instance, a series hybrid hydraulic powertrain for the HMMWV was shown to improve fuel economy by over 70 percent in the federal test cycle. This translates directly into reduction of vehicle operating cost, extension of range and reduction of the logistical burden for military applications. A state-of-the-art *engine-in-the-loop* facility was then used to couple a clean diesel engine to a virtual vehicle, allowing validation of fuel economy predictions and direct insight into the emission-reduction potential.

Additional impact on the energy picture is achieved through investigations of alternative fuels for heavy-duty engines. Replacing part of fossil fuels with synthetic fuels, created from natural gas or coal, can greatly reduce reliance on foreign oil. ARC researchers are focusing on the interplay between new fuels and advanced combustion technologies in order to maximize the benefits. Technology transfer is pursued through partnerships with industry. In particular, awards from the new Michigan 21st Century Jobs fund will allow transition from basic research toward commercialization of competitive technologies in the area of efficient hydraulic hybrid propulsion, with Bosch-Rexroth as

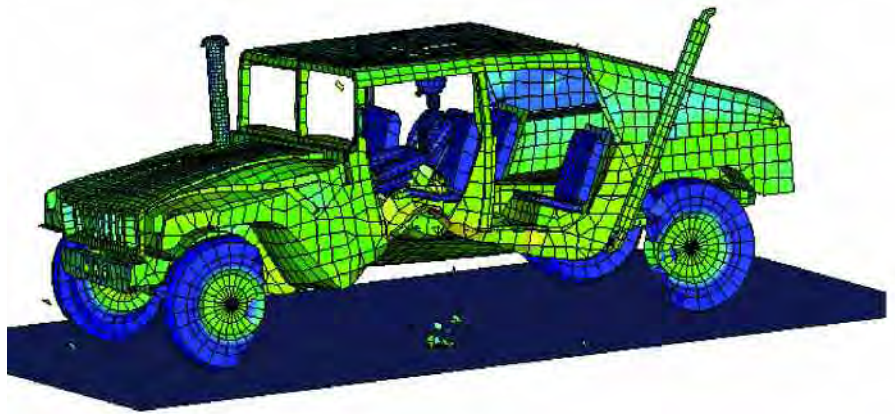

Component layout for a hybrid hydraulic U.S. Army HMMWV. The ARC is using computer simulation to demonstrate the power and emissions requirements of the hybrid hydraulic concept.

partner, and advanced diesel aftertreatment devices, with EATON as a partner.

ARC modeling and simulation tools are revolutionizing not only the energy efficiencies of civilian and military vehicles but also their safety. New technologies are being developed to both prevent and mitigate unsafe events. On the prevention side, the ARC has developed a new force-reflecting joystick that cancels biodynamic feed-through and only responds to volitional driver commands. Such a joystick can significantly improve vehicle system stability in harsh environments, and its efficacy is being validated using human subject testing on the U.S. Army Tank-automotive and Armaments Command ride motion simulator in Warren, Michigan. The ARC has also partnered with DaimlerChrysler to develop an algorithm capable of estimating the mass and center of gravity height of a vehicle reliably, in real time, using minimal instrumentation. Using such an algorithm, both military and civilian vehicles can adaptively calibrate their active safety systems for variations in loading.

On the mitigation side ARC modeling tools are being used to make vehicles safer in the presence of impacts, whether due to on-road accidents or improvised explosive devices. Specifically the ARC is developing revolutionary morphing structures that deploy in the event of a crash or blast, thereby absorbing the shock and protecting passengers and pedestrians. Furthermore

ARC researchers are using energy finite element analysis to characterize the effects of blast and high-frequency vibration. The center is developing a comprehensive framework for efficiently integrating distributed models, simulation codes and new design methodologies for commercial and military applications. This supports analysis and design of Army's current and next generation of tactical vehicles.

Vehicle durability is an important attribute of both military and commercial vehicles. Structural dynamics of vehicles in the low- to mid-frequency range is a critical contributor. ARC researchers conduct vibration analyses of vehicle substructures separately and then incorporate them into one model. When parameters of any one component change, the entire structural response can be simulated faster and thus facilitates the exploration of more configurations in less time. Additionally other research on reliability-based design optimization tools allow for significant weight reduction of vehicle components. The tools help to achieve both weight savings and improved fatigue life. These ARC-developed software tools are transferred to the Army and industry to use in their diverse vehicle programs.



# GM / U-M Collaborative Research Laboratory Accelerates the Development of Highly-Efficient and Ultra Clean Engine Systems

The General Motors Collaborative Research Laboratory for Engine Systems Research (GM/U-M CRL ESR) had a strong year, continuing to serve as a model of a research partnership between industry and academia. "The collaborative lab at U-M carries-out R&D activities in areas that are of strategic importance to GM", said Dr. Gary Smyth, Director of the Powertrain Systems Research Lab at the General Motors Research & Development Center. "GM has ambitious goals regarding development and introduction of highly-efficient, clean powertrain technologies." GM/U-M CRL ESR Co-Director Professor Dennis Assanis said, "Our partnership with GM provides tremendous research opportunities for our graduate students and allows continuous refinement of state-of-the-art experimental facilities in the W.E. Lay Automotive Laboratory."

Research in the optical diagnostics thrust area, co-led by Professor Volker Sick and Dr. Rodney Rask, GM combustion systems group manager and GM/U-M CRL ESR Co-Director, is focused on the development and use of new imaging techniques. Understanding the complex coupling of physics and chemistry related to ignition stability in spray-guided spark-ignition direct-injection (SIDI) engines is crucial to develop the technology that is required to reliably operate these efficient and flexible engines. Fast camera and laser technology is used to simultaneously image the fuel concentration, flow fields and spark discharge in an optical engine so that their interplay can be understood and used to build predictive computer models for design purposes. Combined planar laser-induced fluorescence, particle image velocimetry, and plasma emission imaging at thousands of images per second also provides insight into the particular microscopic impact that the type of fuel has on ignition and combustion stability. New to the group is work on computational fluid dynamics aiming at the development of ignition models that can describe the start of combustion. Flexible fueling capability of spray-guided SIDI engines is currently examined in studies with alcohol fuels, such as ethanol and butanol.

In the thrust area devoted to thermal characterization of direct-injection engines, under the co-direction of Zoran Filipi, research associate professor at U-M, and Paul Najt, manager of spark ignition engine systems at GM, researchers conducted an extensive experimental study to understand the effects of combustion chamber deposits on homogeneous charge compression ignition (HCCI) engines. Previous studies on conventional spark-ignited engines have shown the effect

of deposits on knock and fuel octane rating. Since HCCI engine combustion can be conceptually described as "controlled knock", a hypothesis was made that combustion chamber deposits could directly affect the main combustion event. Indeed, the pioneering study at U-M documented significant acceleration of HCCI burn rates as a function of deposit layer growth. In addition, fast response thermocouple measurements on the combustion chamber metal surface provided a first glimpse into thermal properties of deposits without their removal. This insight contributes directly to development of robust control strategies and techniques for expansion of the HCCI operating limits.

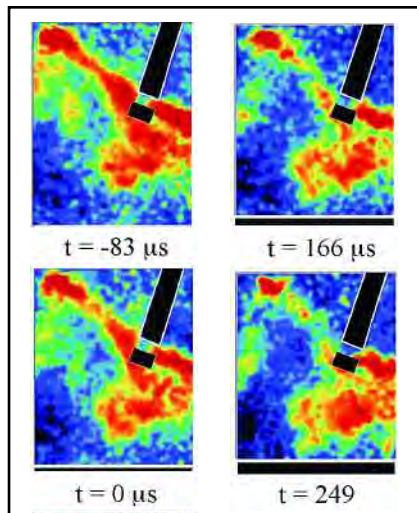

Images showing alcohol fuel concentration near the spark plug at the time of ignition. Time is relative to spark initiation.

In the thrust area devoted to premixed diesel combustion and aftertreatment, co-leaders Dennis Assanis, ME professor and CRL co-director, and Pat Szymkowitz, manager of diesel engine systems at GM, are directing work aimed at dramatically reducing particulate matter and NOx emissions. To meet the U.S. Environmental Protection Agency's regulations which go into effect in 2007-2010, the team has developed novel Premixed Compression Ignition (PCI) strategies to expand the low-temperature combustion range using retarded injection, variable geometry turbocharging and high exhaust gas recirculation schemes. Furthermore, the team is combining its combustion strategies with aftertreatment devices

specially formulated to tackle unburned hydrocarbons and CO from PCI combustion.

The fourth thrust area, dedicated to modeling of engine and aftertreatment systems and co-led by Assanis and Dr. Andreas Lippert, manager of engine systems modeling at GM, is intimately connected with the experimental work in the first three thrust areas, but is focused on model development. During the past year, work concentrated on developing predictive models of after-treatment components that can be applied to optimizing engine aftertreatment systems. In particular, by analyzing data acquired in lab reactors under controlled conditions, new models of reaction kinetics in lean oxidation catalysts have been developed and validated with engine experiments. In addition, breakthrough work has been carried-out to model zeolite catalysts that can absorb unburned hydrocarbons during cold start. Other efforts have focused on modeling sprays and fuel-air mixing in PCI combustion, as well as exploring the role of thermal and compositional stratification of the mixture in extending the operating range of an HCCI engine, in close collaboration with the work of the DOE LTC consortium.

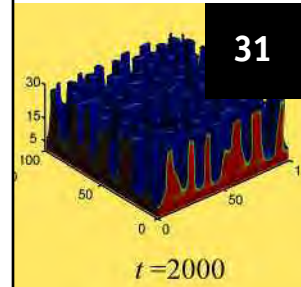

research

# U-M/GM Form Collaborative Research Laboratory for Smart Materials and Structures

General Motors Corporation and the University of Michigan Department of Mechanical Engineering have established a new Collaborative Research Laboratory for Smart Materials and Structures. The nearly \$3 million effort will focus on basic smart material research, smart device innovation and mechatronic design methodology.

Smart materials and structures (SMS) lend themselves well to numerous automotive applications including smart pumps and injectors, smart latches and locks, energy absorbing and harvesting materials and active safety systems. There are significant potential benefits to be realized including reduction in vehicle mass, added design flexibility and reduction in component size and cost.

The close collaborative relationship between the SMS groups at U-M and GM began in 2002 when Associate Professor Diann Brei spent a sabbatical year at GM Research & Development working on a single project related to automotive safety. The relationship grew to include other projects and other researchers in the College of Engineering, including ME Assistant Research Scientist Jonathan Luntz and Aerospace Associate Professor John Shaw. During a project review in January 2006 with Dr. Alan Taub, executive director of science at the GM Research & Development Center in Warren, Michigan, it was clear to him that the Collaborative Research Laboratory was already present in spirit and just needed to be formalized. The two organizations finalized their agreement for a new CRL in May.

GM is actively working in mechatronics, or the integration of mechanical systems, smart materials and electronics, relative to automotive applications. The company holds more than 35 patents and has published more than 70 patent applications. "Smart materials and structures have been around for twenty years now; they're becoming mature to the point where they can be transitioned to the marketplace. But there's still that gap between what happens in academic research and getting products out there. GM and U-M are working in collaboration to narrow that gap," said Brei.

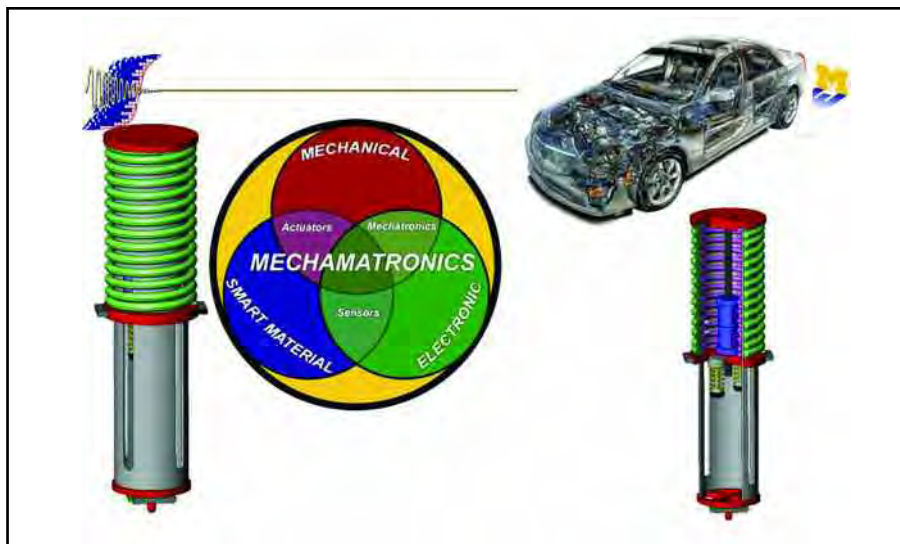

Graphic representation of the work undertaken in the new U-M/GM Collaborative Research Laboratory, including CAD models of a hood-lift device for pedestrian protection. The circular diagram represents the emerging field of Mechatronics, which combines mechanical design, electronics and controls, and smart materials.

GM will be involved on a nearly daily basis with the basic research process. Likewise, U-M researchers will take new technologies to a higher level of prototyping than a university typically would so that suppliers and industry can better see the potential and more easily put it into production. By staying involved longer, U-M researchers "will see the true basic research issues that constrain the adoption of smart materials in industry, and that will feed back into our core research program. We'll be able to address those issues from an academic standpoint to make the technologies viable," said Brei.

The CRL will be co-directed by Brei and Nancy Johnson, manager of Vehicle Structures at GM R&D, who will oversee the three thrust areas that comprise the CRL. The first thrust area, Smart Device Technology Innovation, will focus on identifying opportunities where smart materials provide a commercially viable, competitive edge. "The full expectation here is that we'll develop revolutionary technologies, those that have never been done before. We'll lay the scientific foundation so that devices from these novel technology families can be quickly transitioned to real suppliers for incorporation into automotive applications," said Brei. This thrust area will be co-led by Luntz of U-M and Paul Alexander of GM, who is a recent graduate of the ME department.

The second thrust area, Smart Material Maturity, will ease the path to commercialization by maturing the understanding of smart materials through experiments and modeling of materials behavior and durability testing. The focus will be to target those issues needed to transition smart material applications to market. "This CRL is a unique opportunity to address fundamental scientific and engineering problems of relevance to the automotive industry, and I'm excited about the prospect of seeing smart material applications in the marketplace," said Shaw. This thrust area will be co-led by Shaw and Nilesh Mankame of GM.

The third thrust area, Mechatronic System Design Methodology, will focus on developing design, modeling and analysis tools for suppliers and industry to use. The key here, said Brei, is to design sophisticated, rigorous tools that engineers can use. In addition, the CRL is building up world-class experimental capabilities, starting with a full car testbed. This thrust will be co-led by Brei and Alan Browne of GM.

To establish the necessary workforce to support this effort, U-M is also offering several graduate courses in Smart Materials and Structures.





New U-M/GM CRL thrust area leaders, researchers and administrators. Seated in front are co-directors Nancy Johnson of GM (left) and Diann Brei of U-M (right).

The CRL is a global effort with partners across the nation and world from GM's Global Research Network, such as HRL Laboratories in California and GM's India Science Lab in Bangalore, India. Finding additional strategic partners is a goal too, and Brei hopes to involve other noncompetitive industries, small businesses and government agencies in the venture.

Such a high level of collaboration is unique among university researchers and industry partnerships, said Brei, but necessary. "It will enable us to propel into the future and create leapfrog-type technology, which will advance the auto industry through use of new paradigms of design and innovation based upon a solid scientific foundation."

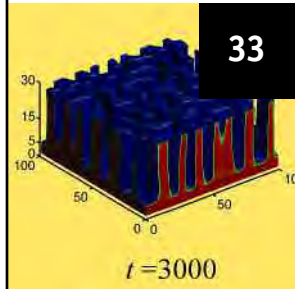

## Insights Into Elastomeric Deformation

**M**E Professor Alan Wineman, working with Professor John Shaw in the Department of Aerospace Engineering, is taking the study of elastomeric deformation in new directions. In research supported by Sandia National Laboratories, the National Science Foundation and Tenneco Automotive, Wineman and Shaw are exploring the degradation of elastomers at high environmental temperatures.

The phenomena the two are investigating directly affect items such as rubber tires, seals in power equipment and engine mounts and bushings, all of which degrade over time, particularly when exposed to high temperatures or they self-heat. Their degradation can lead to catastrophic behavior.

The project is focused on the modeling — and experimental validation — of materials undergoing very large deformations and changes in their chemical structure. It blends traditional mechanics with polymer science and involves deformation, heat transfer and oxygen diffusion. These phenomena all interact in complicated and heretofore unexplored ways. Wineman and Shaw have

been conducting the joint research for six years.

To date the duo has partially validated their model, and they are also carrying out new experimental techniques to include multi-axial deformations.

In addition to automotive applications, the National Institute of Standards and Technology estimates that the deterioration of window caulk from high temperatures, ultraviolet radiation and water causes some \$60 million in damage annually. "We think our approach can be used to assist NIST with its building safety programs," Wineman noted.

The modeling of large deformations of elastomeric materials under adverse environmental conditions combines several previously unrelated phenomena. "We hope our approach provides a model for research for other complicated interactive problems," Wineman said.

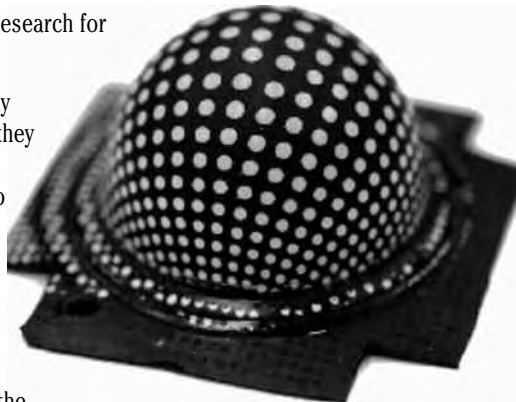

**An initially flat sample was pressurized by glycerine at 125 degrees C for 25 hours. The glycerine was removed and the membrane was cooled to room temperature. The membrane developed a permanent set. This is explained by a process consisting of the scission of macromolecules and crosslinking in the current state.**

research

# Creative Approaches to Vehicle Safety



**N**oboru Kikuchi, the Roger L. McCarthy Professor of Mechanical Engineering, has spent years solving problems in computational mechanics, including the mechanics of composite materials and structural design optimization for automotive applications. More recently he has focused almost singularly on one aspect: improving vehicle crashworthiness.

Safety has improved dramatically in the past 10 to 15 years with the use of seatbelts, airbags and new designs, but “it’s not yet sufficient,” he said. “I myself have been working in the automotive area for 25 to 30 years and always paid attention to the government regulation that crash tests be done at 35 mph.” But one day several years ago Kikuchi was working on a computer simulation. He changed the crash conditions, increasing the size of one of the vehicles and increasing the speed at impact. He didn’t like the results. He has since been conceiving of and modeling advanced materials and technologies to improve vehicle safety.

In work that is supported by the U.S. Air Force and National Science Foundation he is designing sophisticated sensor and radar systems to detect an impending impact. “For passenger cars, a system that is capable but inexpensive is critical,” he said. Such systems require an antenna that can manage several wavelengths simultaneously in order to receive signals from multiple sensing devices. These systems also require specialized electronics and packaging to weather harsh environmental conditions.

He is also investigating the use of novel devices to reduce the speed of impact, including an “active bumper” released before impact and expandable trusses. The latter—

about five millimeters thick—can also be embedded into “active armor” on military vehicles to reduce the effects of blast. The U.S. Army is supporting this work, which has been modeled and is nearly ready for testing.

Other technology includes a bumper airbag. In computer simulations the device slows the speed of impact by 50 percent. Although Kikuchi has been modeling the use of different materials, carbon fiber is proving the most promising. “It can sustain a fairly significant load, and it’s lightweight. The blast (that deploys the airbag) can be contained within the airbag so we can use more explosive, which can decrease the speed even more.”

Modifying an automobile’s front posts to include lattice-patterned material that absorbs more shock is yet another idea he is looking at. He has also been modeling the effects on pedestrians when the posts are filled with tiny particles, one or two millimeters in diameter. Upon impact the particles, which are filled with water or a polymer, scatter on the ground and provide a thin “cushion” for the injured pedestrian. In simulations the particle layer has decreased head injury criteria (HIC) by 50 percent.

Kikuchi realizes some of his ideas may seem unconventional, but he believes that creativity is necessary to solve difficult problems. So is developing and disseminating those ideas. He spends much of his time talking with industry representatives. “I’m always going and talking and showing,” he said. “There’s solid research behind these technologies, and the research has to be integrated with education of the public, industry and government. Safety is a common issue all over the world...we have to do anything we can.”



# UMTRI Projects Accelerate

Since ME Professor Tim Gordon was appointed head of the Engineering Research Division of the University of Michigan Transportation Research Institute (UMTRI) just three years ago, he's seen several of the institute's projects accelerate.

Working with UMTRI's Human Factors division, Gordon's division is leading a \$25 million U.S. Department of Transportation grant for the test and development of future

Integrated Vehicle-Based Safety Systems. Industry partners on this project include Visteon Corp., Eaton Corp., Cognex Corp., Honda R&D Americas, Battelle Memorial Institute and the Michigan Department of Transportation.

The aim is to evaluate the future safety benefits of systems that sense conflicts and warn drivers when they are about to drift off the road, collide with the vehicle in front of them or hit another vehicle during a lane change. Run-off-road accidents alone account for 40 percent of all vehicle fatalities in the United States, so the potential payoff is significant.

"What makes this so interesting is that it involves the driver interacting simultaneously with several vehicle systems at the same time," said Gordon. "Research is needed in the real-world environment to see whether this can be truly effective." The project builds on earlier field tests that have so far gathered nearly 1 million miles of detailed driving data.

A larger study commencing in 2007 involves working with Virginia Tech, Transportation Institute and others groups to design a large-scale experiment to instrument and record the so-called *naturalistic driving* behavior of U.S. motorists, with a focus on crash causation and risk. The largest such study ever conducted, it will provide a new and massive data resource for crash risk analysis. Ultimately it will support new analyses of crash causation, and the development of safer vehicles and safer highways.

Over many years Gordon's division also has conducted modeling and testing work on heavy truck dynamics, particularly in the area of truck rollovers. A new Hardware in the Loop Simulation lab is being set up to test and evaluate the effectiveness of control systems for improving truck



**Making trucks roll over to validate computer models.**

stability and preventing rollovers. In this same area, tests were recently conducted in Michigan's Upper Peninsula using two instrumented trucks fitted with robotic steering controllers. The trucks were forced into severe maneuvers that caused them to roll over. The experiments validated the models developed to calculate impact loads related to the integrity of tankers containing hazardous materials.

UMTRI researchers also instrument the road. Gordon's division has built a prototype video-based vehicle tracking system to better understand driver behavior with regard to braking and time spacing, steering, acceleration and other vehicle motion characteristics.

A pilot project using a first generation system concluded in 2000, and the newer system will be deployed in some upcoming projects. The second generation system includes digital cameras and the use of multiple cameras to capture images from different positions to improve the accuracy of tracking. Gordon is leading a new project in this area, working with the California PATH Program at the University of California, Berkeley, again with a focus on understanding the detailed factors involved in highway crashes.

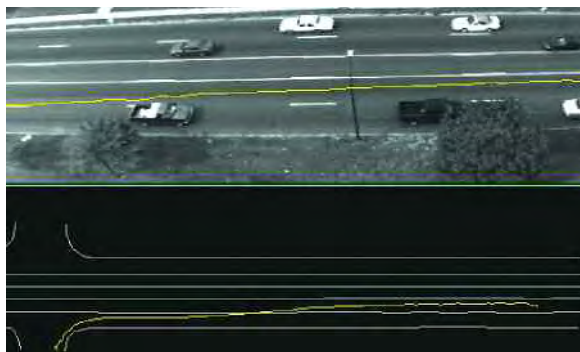

**Video-based motion tracking of vehicles for conflict analysis.**

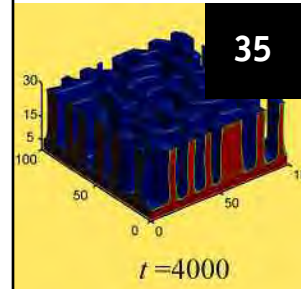

research

# New MEng Program Off to a Quick Start

The College of Engineering now offers a new Master of Engineering (M.Eng.) degree program in Global Automotive and Manufacturing Engineering (GAME), thanks in large part to the work of two ME faculty, Professors Huei Peng and S. Jack Hu. Peng and Hu played key leadership roles in the development of the program, in their capacities as Directors of the Automotive Engineering Program (AUTO) and the Program in Manufacturing (PIM), respectively.

The GAME program represents an evolution of the College's interdisciplinary and professional education. ME has been a leader in this effort, pioneering the development of the PIM Program in 1993 (Professor A. Galip Ulsoy was Founding Director) and the AUTO Program in 1995 (Professor Dennis Assanis was Founding Director). Both grew to more than 100 students each in their peak times and have been part of the Interdisciplinary and Professional Programs (INTERPRO) in the College of Engineering since 1998.

More recently Hu and Peng saw the need for a new degree program that integrates elements of both automotive systems and manufacturing. "It's critical that students studying design know about manufacturability, and vice versa," said Peng. The two also saw the need for a program that is available to professional engineers globally. In 2004 Peng and Hu began working with leaders of the General Motors Technical Education Program on the new degree program. Collaboratively, UM and GM leaders performed global needs assessment and designed the new curriculum to address these needs. They envisioned a program that would cultivate a global community of technical leaders with several attributes: outstanding depth and breadth in core engineering disciplines; knowledge of related management and systems issues; the ability to work virtually and collaboratively to lead global teams.

Launched in Fall 2005, GAME's first year was a tremendous success. One hundred thirty three students from General Motors enrolled, hailing from the United States, Australia, Mexico and Canada.

What sets the program apart, said Hu, is how it incorporates carefully selected courses from nearly two dozen universities around the world. All students must take a course in "High Performance Distributed Technical Teams," taught by the University of California at Los Angeles. To reflect the truly global nature of education, a student can take up to 12 credits of pre-approved courses from these partner universities and transfer them to UM toward their degree. "That way we can provide the best educational experience for these global students," said Peng. Most engineering schools allow only six transfer credits, he explained.

Admission requirements are similar to other master's programs in Engineering, with an additional requirement of at least one year of industrial experience.

"Working with GM, we've done something unique," said Peng. "It's a one-of-a-kind partnership characterized by interdisciplinary content, multi-university curriculum design and delivery and our expertise in serving global audiences."

Since the time the GAME degree program was launched, Professor Jack Hu and Professor Huei Peng have assumed new roles. Professor Hu is now the Associate Director for Research in the College of Engineering, and Professor Peng is directing a new organization merging INTERPRO with the former Center for Professional Development (CPD). Replacing them as Directors of AUTO and PIM are Professor Margaret Wooldridge and Professor Jan Shi, respectively.

# Changes in the Guard

## THANKING THEM FOR THEIR SERVICE



### Greg Hulbert

Professor Greg Hulbert served as Undergraduate Program Director and ME Associate Chair between June 2002 and December 2006. He has been responsible for the annual teaching plan and for coordinating the continual process of assessing and improving our ME undergraduate curriculum, which culminated in the very successful ABET review and accreditation of our program until 2011. During Greg's term, student enrollment in our undergraduate program has returned to its all time high level (over 660 students). Despite the record enrollment Greg continued to foster an environment for excellence in instructional delivery, and for the first time, all ME required undergraduate courses reached three-year averages above 3.0/5.0 for both the Q1 and Q2 scores.

## WELCOME ON BOARD

### David Dowling



Professor David Dowling is the new Associate Chair in charge of the Undergraduate Program since January 2007. His research in the fields of acoustics and fluid mechanics ranges from fundamentals to their applications to fans, mufflers and washing machines. He is a demanding and respected teacher at the undergraduate and graduate levels. He has successfully developed and regularly teaches undergraduate and graduate courses in acoustics. He has also played a leadership role in developing and revamping the required junior laboratory course ME 395. He has previously served the ME Department as a member of the Undergraduate Program Committee, the Faculty Search Committee and the Advisory Committee. As part of his new role he will lead the efforts to continue to improve our undergraduate curriculum.



## Arvind Atreya



Professor Arvind Atreya has served as ME Associate Chair and Director of our Graduate Program between September 2003 and December 2006. Professor Atreya has overseen the development and implementation of methods to improve the graduate application review and recruitment process and shared best practices with other departments. During

Arvind's term, our graduate program reached an all time high enrollment of over 500 students and graduated the highest number of Ph.Ds in a single year in our history with a significant number of them accepting positions in academia. Arvind has led the effort to assess various alternatives for revamping the Ph.D. qualifying exam process, thus laying the foundation for the major reform which is being implemented as of fall 2007.

## Marcy Brighton



Marcy Brighton, Administrative Manager of the ME Department between January 2000 and September 2006, has been promoted to Director of Resource Management and Planning in the College of Engineering. Marcy's contributions to the ME Department will be dearly missed. Marcy has been committed to excellence and

provided dedicated service to our Department and the College, which has been recognized by the CoE Staff Excellence Award and the UM Workplace Finalist Award. She always upheld high standards of professionalism, perfectionism, ethics and fairness. She has had a tremendous impact on improving staff morale in our department while improving the quality of staff services.

## Karl Grosh



Professor Karl Grosh is the new Associate Chair in charge of the Graduate Program since January 2007. His research interests are in cochlear mechanics, the biomechanics of growth, and the design and fabrication of electroacoustic transducers. Professor Grosh is an effective instructor, both inside and outside of

the classroom, who is described by students as "enthusiastic," "animated" and employing an "extremely effective teaching method." He is particularly skilled working one-on-one with students, whether in office hours for his courses or in research meetings with his graduate students. He has previously served on the ME and BME Undergraduate Program Committees, the ME Advisory Committee and the College's Scholastic Standing Committee. In his new role he will spearhead the revamping of our graduate core curriculum.

## Merlis Nolan



Merlis Nolan is the new Administrative Manager of the ME Department effective November 2006. Prior to her current position, she has been the Administrator of the Department of Biological Chemistry in the Medical School (2003-06). Merlis projects contagious energy and enthusiasm, and has great communication and interpersonal skills. Her approachable personality

and her open — and with a sense of humor — supervisory style, infuses excitement to the staff, faculty and students she interacts with. Merlis has had direct experience with many of the elements of the typical operation of a smaller UM Department and she is ready for the challenge and growth opportunity that ME presents to her.



Images showing flame progress in the combustion chamber of an alcohol-fueled spray-guided spark-ignition direct-injection.

# Department Statistics and Trends

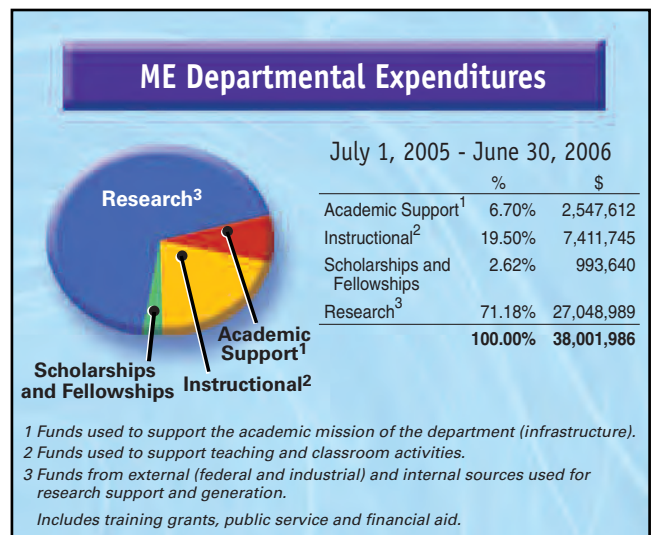
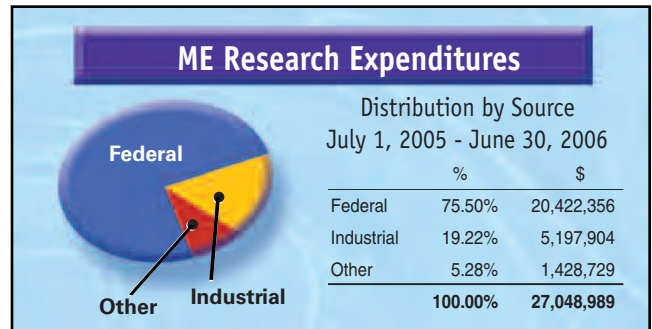
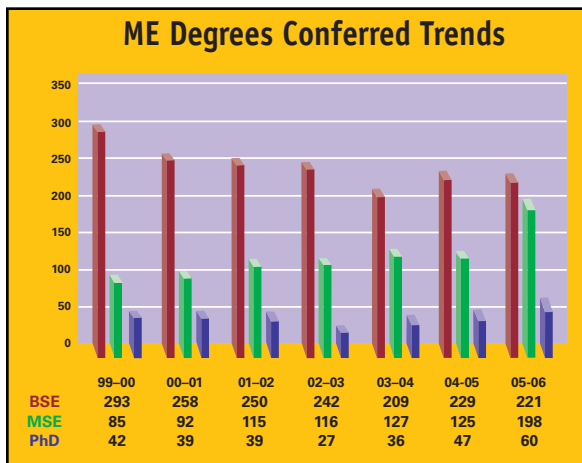
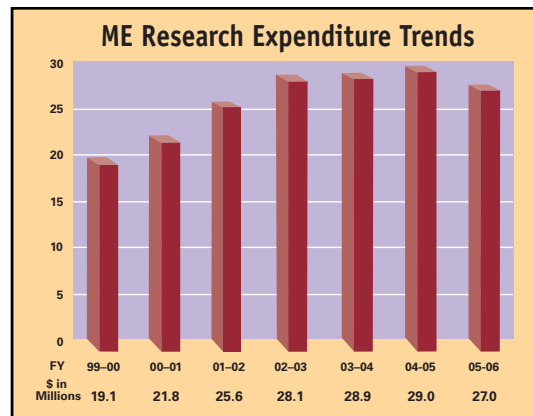
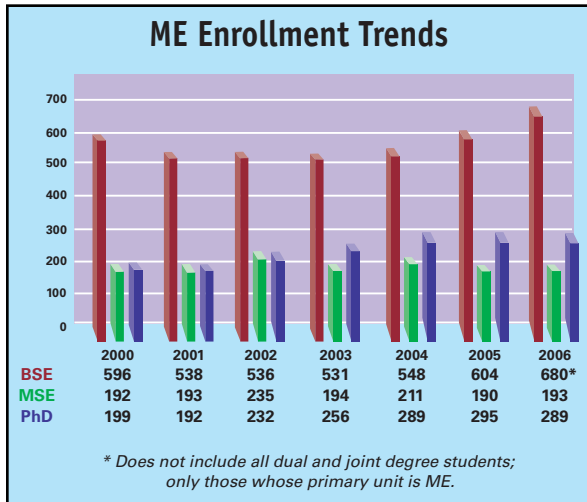



# Reconfigurable Manufacturing Systems ERC Transfers Technology

**T**echnology transfer is enhancing the Center's impact on industry, evoking a new motto: "Taking science to the factory floor." There are now over a dozen projects conducted together with industry at industry sites with the goal of utilizing scientific methods in production plants. Results of these projects include enhanced product quality, increased productivity, and improving the speed of responsiveness to the customer's needs.



**ME450 students working on a prototype parallel kinematic device in the ERC-RMS. The device works by sliding rigid elements closer to and farther from each other along parallel rails. The result is rapid, repeatable movement of a carriage connected at the bottom to all three elements.**

"The Engineering Research Center for Reconfigurable Manufacturing Systems has been conducting fundamental research for ten years, and now it is time for us to work with our members to harvest," said Professor Jun Ni, the Center's deputy director during 2002-2006.

Successful technology transfer has been the key focus over the past academic year. "We are working closely with industry to deploy and implement the results of our research and to build even stronger partnerships with member companies to launch our industrially-focused activities."

The ERC-RMS is working on several such activities with General Motors. The company has evaluated the ERC's Reconfigurable Inspection Machine (RIM) for the detection of surface porosity in its manufacturing environment. It has recently commercialized a system for its Flint Engine Plant, which was installed during 2006.

GM is also validating a stream of variation measurement reduction methodology to reduce the number

of inspection measurements required while maintaining product quality. The company is looking at increasing the part sampling frequency by alternating the measurements of feature groups. Optimal design of the method will lead to increased part sampling frequency yet reduced inspection time per part.

DaimlerChrysler and Ford have used the RIM for surface porosity detection. ERC-RMS students along with plant personnel at Global Engine Manufacturing Alliance (GEMA), a joint venture of which DaimlerChrysler is a member, in Dundee, Michigan, tested the porosity on some 600 parts. DaimlerChrysler has issued a request-for-proposal to vendors to build an in-line system for one of its engine block assembly lines. In addition the ERC-RMS is demonstrating an open-architecture, event-driven software system linking process and maintenance data systems to reduce unscheduled down-and repair time at the plant.

Ford Motor Company has used the ERC's Performance Analysis for Manufacturing Systems (PAMS) system design software to balance machine and assembly operations to reduce potential bottlenecks at its Cleveland engine facility.

"The center is at a point in maturity where the investment in fundamental research is now paying off," said John Cristiano, who served as the center's assistant director for industry relations during 2005-2006. "This is very rewarding for both university faculty and industry participants who have worked hard over the years to build the ERC-RMS research organization."



**The ERC-RMS "Arch-type" reconfigurable machine tool (RMT) is the first of a new generation of easily reconfigurable production machines. It was built for the Center by Masco Machine Tool in 2002. The Arch-type is able to perform as a horizontal milling center as well as diagonal in 15° intervals.**

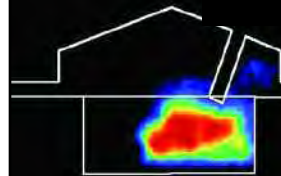



# High School Students in Italy See Factory Testbed in Action

Videolezione dall'università di Detroit  
Itis, giovedì il collegamento con l'ex studente ricercatore nel Michigan

**I**n fall 2005, high school students in Italy got to see the Reconfigurable Factory Testbed (RFT) at work in the Engineering Research Center for Reconfigurable Manufacturing Systems at U-M. And they had the experience without embarking on a transatlantic field trip.

The demonstration was possible thanks to some widely available technology, including Internet telephony, instant messaging and a webcam. Students from the Istituto Tecnico Industriale Liceo Scientifico Tecnologico Statale E. Fermi, or State Institute for Industrial Technologies, in Mantova, also used Google Earth, “just to visualize where Ann Arbor is on the planet,” said Lorenzo Vesentini, an automation engineer in Italy.

Vesentini, who works for an Italian company that develops electronic components for plant and machine automation, had sought the assistance of ME Associate Professor Dawn Tilbury while working on his thesis in 2003. At the time Vesentini was a student at Politecnico di Milano, an Italian university.

Vesentini is also a graduate of the technical high school in Mantova and, having kept in touch with the school’s director and teachers, helped coordinate the RFT demonstration there. Bruno Rosignoli, a teacher at the high school also played a key role.

“The RFT testbed is a great example of the application of many things that are studied at ITIS,” said Vesentini. “Since several specializations are offered by the school — mechanical, electrical, electronic, computer science, etc. — lots of students are interested in learning what can be done by combining together different knowledge. So that’s how the idea about doing the demonstration was born.”

About 50 to 60 students watched — and remotely operated — the RFT as it produced a wax engine. Their reactions to the one-of-a-kind platform that combines actual and virtual equipment linked by a unified software architecture were “enthusiastic,” said Vesentini. “They liked not only the RFT, but also the chance to see something from the U.S. live, listening to something done in English that was from ‘everyday life’ and not just done as an exercise in English.”

The high school students had plenty of questions, which spanned research being developed on the RFT to life in Ann Arbor and at an American college. Vesentini said he thinks the U-M students learned a lot too: “With the Internet the world is definitely smaller and easier; to communicate with other people is just a matter of will. And Europe and America are really close from a cultural point of view.”

For him, “It was really an honor to have the chance to set up this presentation, to give the chance to other young students to understand that studying and working hard is worthwhile, because really interesting things like RFT can be done.”



Students in Italy watch the ERC-RMS' Reconfigurable Factory Testbed in Ann Arbor. Robot loaders (yellow) pick parts from a track and place them into machine tools (white aperture) for processing. The testbed allows for the integration of a suite of machine operations, including real and virtual tools, as well as facilities in other factories. It can be controlled remotely via a Web-based human/machine interface.



# Wee Wizards to Inspire Future Engineers

Outreach to the next generation of manufacturing engineers is a key component of the educational mission of the National Science Foundation Engineering Research Center for Reconfigurable Manufacturing Systems (ERC-RMS). “All indications show that the current generation of young people is the most industrially illiterate we’ve seen. If we’re going to retain a strong manufacturing industry in the future, we must begin educating children early,” said Professor Yoram Koren, the center’s director.

Lenea Howe, the center’s education coordinator, and Rod Hill, the center’s graphic designer, were discussing this problem one day. Howe and Hill were officemates, both with backgrounds in art. “I smell a coloring book,” Hill recalled Howe saying. At the time Howe was researching manufacturing history for a textbook. She was immersed in readings about Eli Whitney and interchangeable parts, Henry Ford and his moving assembly line. The coloring book could incorporate manufacturing history as a way to introduce kids to some key concepts, she suggested.

The project took shape over the next few months and a prototype earned approval — and much enthusiasm — at the center’s annual visit from the National Science Foundation Site Review Board shortly thereafter.

The result of Howe and Hill’s work is a 22-page activity book, *Wee Wizards Explore Making Things: How Manufacturing Works and Why It Is Important*, geared toward kids in grades 5 through 7. Howe and Hill, working with U-M art students who developed and drew a small cast of characters and illustrations, also produced a corresponding teacher’s edition. The Society of Manufacturing Engineers solicited funding to print and distribute a pilot run of 5,000 copies of each publication to science and technology teachers throughout Michigan.

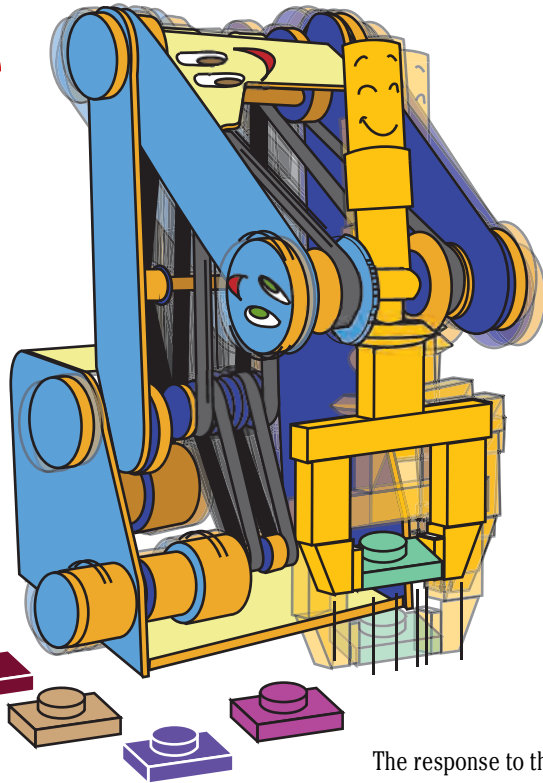

The response to the project was “tremendous,” said Hill. Requests came in from all over the world after the coloring book was featured on the U-M College of Engineering website. *Assembly* magazine ran a brief article about it. Industry has expressed interest. The NSF was so enthusiastic about the idea that representatives requested a larger activity book aimed at elementary-age audiences. “Their request shows the need for education at different levels — a couple of years ago the focus was middle school. Now it’s early elementary,” said Howe.

*The Kitchen Table Fun Book of Manufacturing: How Things Are Built One at a Time and by the Thousands* is now in draft form. It features a diverse ensemble of characters that include both kids and critters: young humans Callie and Hayward; a spider who designs; an ant who fosters teamwork; a firefly with innovative ideas; a bee concerned about quality; and a crab who has mastered repetitive motion. Narrative, experiments, word puzzles, poems and dozens of images and illustrations comprise the 90-page workbook that is meant to engage not only its young readers but their caregivers as well.

“We want it to be the most beat-up book in the kids’ library,” said Howe, who hopes its young readers will realize that a career in manufacturing engineering can be exciting, rewarding and, most importantly, within reach.



Images from the *Wee Wizards* activity book.

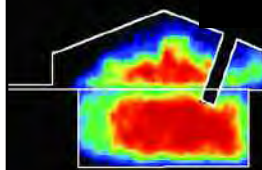

# New Directions in the S. M. Wu Manufacturing Research Center

The S.M. Wu Manufacturing Research Center has undertaken a number of new research initiatives in the past year, according to Professor Jun Ni, the center's director.

In the area of energy device manufacturing, several investigations are underway, including fuel processor design and manufacturing and fuel stack manufacturing. The center has its own fuel cell laboratory and has developed a process for manufacturing a heat exchanger component. Improved manufacturing design processes for fuel cell components and applications are critical to fuel cell adoption; currently the time and cost involved in manufacturing fuel cell stacks are two major obstacles to their use.

In Fall 2005, the Center's deputy director, ME Professor Albert Shih, developed a graduate-level course, Biomedical Manufacturing, which will be offered again in Winter 2007. This course features extensive teaching and project collaboration with U-M Medical School faculty and visits to medical device manufacturers Stryker and DePuy. Work on a number of promising projects will continue, including on a new surgical thermal management system. Shih and co-investigator, Dr. Arnold Advincula, a clinical assistant professor in Obstetrics and Gynecology at the U-M Medical School, recently received a grant from the U-M Medical School Translational Research Program. Another research grant from the National Science Foundation has also been awarded to Shih and co-investigator, Dr. James Geiger, associate professor of Pediatric Surgery at the U-M Medical School. Together, they will explore novel surgical instruments for nerve sparing surgical techniques to prevent the continence and potency problems that are often

consequences of hysterectomy and prostatectomy. The problems affect about 70 percent of men who undergo prostatectomy and between 30 and 40 percent of women who undergo hysterectomy. The researchers' nerve-sparing technologies will enhance the post-operative quality of life.

Shih and his collaborators are looking at how they can apply manufacturing concepts and technologies to healthcare. Shih has developed an analogy of the hospital as a factory. In this model, he explained, "The tissue/patient corresponds to the workpiece; the surgical instrument to the machine tool; the hospital bed to a fixture. The fields of manufacturing science and engineering have been expanded to medical and healthcare service and research, since many manufacturing technologies and concepts can be readily applied for medical, biological and healthcare applications," he said.

The move into medical and biomedical manufacturing is new for the center and new nationwide, according to Ni. "Many people are doing work in the areas of instrumentation and imaging, but we're focusing on the manufacturing aspects of those applications and that's novel."

Also taking cues from the human model is the NSF Industry/University Cooperative Research Center for Intelligent Manufacturing Systems (IMS), which is affiliated with the Wu Manufacturing Research Center. The IMS center successfully completed its objectives for its first five-year period and has been funded by the NSF for the next five years. During this time, the IUCRC will pursue an additional direction in research: Immune Engineering Systems. Just as human beings have immune systems that detect problems

and activate cells to repair and heal them, man-made manufacturing systems need to be able to detect anomalies, isolate them and self-adjust to correct them while minimizing production defects.

New industry partners will be joining the IUCRC, noted Ni, including BorgWarner, Inc., Baosteel, GE Aviation, ETAS and Coherix. Renewing members include General Motors Corporation, Ford Motor Company and DaimlerChrysler.

The Wu Manufacturing Research Center continued its work in traditional manufacturing at the micro and meso scales. Recently center investigators developed novel processes and equipment for micro-milling, grinding, EDM (electrical discharge machining) and forming.

The Wu center again held a successful international conference, the 7th Wu Symposium on Manufacturing Science and 7th International Conference on Frontiers in Design and Manufacturing. Close to 800 representatives of industry, academia and government attended the meeting, which was held in Guangzhou, China. The event was co-sponsored by the National Natural Science Foundation of China, the U.S. National Science Foundation and the Shien-Ming Wu Foundation. In October, the Wu Manufacturing Research Center will co-host the inaugural ASME International Conference on Manufacturing Science and Engineering in Ypsilanti, Michigan, with the NSF Engineering Research Center for Reconfigurable Manufacturing Systems. This annual forum sponsored by the Manufacturing Engineering Division (MED) of the ASME is predicted to draw manufacturing researchers and engineers from all over the world to visit U-M.





*Front row:* Milan Brandt, Raj Patel, Amitabha Ghosh, Volodymyr Kovolenko, Mary Lynn Realff, Mool Gupta, Steven Janse, Rado Kovacevic, and Jianhua Yao; *Middle Row:* Joonghan Shin, Todd Rockstroh, Mikhail Vasilyev, Peter Baker, Klaus Loeffler, Frank Di Pietro, Jyoti Mazumder, William O'Neil, and Donghyuck Kam; *Back Row:* Guru Dinda, Yasuhiro Yamamoto, Susan Sprental, Roberto Ortega-Martinez, Stefan Kairle, Magid Azer, Yuzuru Uehara, and Xiuli He

## Center for Lasers and Plasmas Advances Manufacturing Technologies

The Center for Lasers and Plasmas for Advanced Manufacturing (CLPAM) is becoming a “major voice for lasers and plasmas in this country,” said Jyoti Mazumder, the center’s director and Robert H. Lurie Professor of Mechanical Engineering. Mazumder is the most recent recipient of the Ennor Manufacturing Technology Award for his “pioneering work” in laser-aided manufacturing (see story on page 46, “ME Manufacturing Sets the Pace with Awards”).

An Industry/University Cooperative Research Center, the CLPAM has strong connections with its industry partners. The universities involved include University of Virginia, Southern Methodist University and Columbia University.

The center is transferring technology that averts porosity in galvanized steel welds to Toyota Motor Manufacturing North America, Inc. The technology, which includes a spectral diagnostic technique, solves a long-standing problem in the auto industry: because of zinc’s low boiling point, it evaporates violently at the weld interface and results in high-porosity joints. Until now there has been no production-friendly solution to reduce — or to monitor — such porosity in laser-welded, zinc-coated steel.

“Our technology offers a holistic approach,” said Mazumder. “It solves the problem of zinc explosion and provides a methodology and a magic eye to tell you that the weld is OK. There are tens of meters of welding on every car, so this will have a major impact.”

Center researchers are also working on a single crystal superalloy coating. GE Aviation is duplicating the research in their Cincinnati headquarters in order to hasten the development process. The new technique allows for the co-deposition of a thermal barrier coating using epitaxial growth.

The potential impact is tremendous, Mazumder added. “A lot of high-efficiency jet engines have single crystal coatings. They avoid creep, but they age and the corners erode, which results in a loss of thrust. For poly-crystal coatings there are all kinds of repair methods, but not for single-crystal.”

With Professor Arvind Atreya, Mazumder is continuing his work on the manufacture of metallic nano-crystalline surfaces using high brightness diode-pumped Nd:YAG lasers by rapid melt and quench technique. The team is modeling the microstructure of these surfaces and experimentally quantifying their catalytic behavior to understand their effect on the gas phase. They have developed a production friendly method to manufacture the nano-crystalline surfaces, and the work has potential application in numerous areas, particularly in automotive and aircraft engines to improve hydrogen combustion efficiency.

The center’s work is being applied to biomedical problems as well. Working with industry partner IMRA America, Inc., researchers are developing techniques for the manufacture of three dimensional micro-channel networks that mimic the vasculature of the human lung, allowing for the development of an artificial, implantable organ. Using a diode-pumped fundamental Nd:YAG laser, multi-depth, multi-width microstructures of silicon can be fabricated. Laser micromachining allows for semi-circular micro-channels, which are difficult to achieve using lithography.

Some 700,000 people annually struggle with lung disease, yet the wait for transplants is exceedingly long. “Right now nothing exists that can be implanted, so patients have to lay in bed hooked up to a ventilator,” said Mazumder. “This could really improve the quality of life for hundreds of thousands of people.”

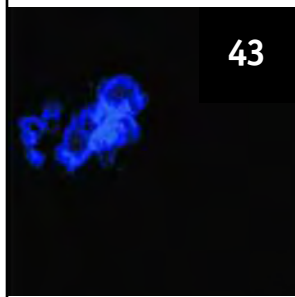

High-speed imaging provides direct time-resolved data on ignition and reaction phenomena during HCCI combustion in single-cylinder research engine.

research

ACCELERATING TECHNOLOGY DEVELOPMENT

# Galip Ulsoy Elected to NAE

Professor A. Galip Ulsoy has been elected to the National Academy of Engineering. Academy membership recognizes engineers who have made significant contributions to engineering research, practice or education. Ulsoy was selected because of his work on the dynamics and control of axially moving elastic materials and their implementation in automotive and manufacturing systems.

“This is a richly deserved recognition of Professor Ulsoy’s professional accomplishments throughout his distinguished career,” said ME Department Chair Professor Dennis Assanis, in announcing the honor.

Currently the William Clay Ford Professor of Manufacturing, Ulsoy studies the dynamics and control of mechanical systems. He has conducted fundamental research on the dynamic analysis and control of rotating and translating elastic systems, as well as on the design of control systems. His work on the dynamics of band saw blades and drills and of accessory drive belts and road-departure prevention systems is extensively cited and has been implemented by industry. He is well-known for his application of methods from advanced control theory to manufacturing systems, and he was an originator of the concept of reconfigurable manufacturing systems.

Ulsoy has served as the founding director of the Program in Manufacturing and chair of the Department of Mechanical Engineering. He served as technical editor of the American Society of Mechanical Engineers (ASME) *Journal of Dynamic Systems Measurement and Control* and is a member of the editorial board of *Mechanical Systems and Signal*



*Processing* and several other international journals. He has also served as editor of the *IEEE/ASME Transactions on Mechatronics*. He is a fellow of the ASME and the Society of Manufacturing Engineers, a senior member of IEEE, and a corresponding member of CIRP. In addition, he serves as vice-president, and president elect of the American Automatic Control Council, which is the national member organization representing the United States in the International Federation of Automatic Control. He has served as the chair of the executive committee of the Dynamic Systems and Control Division of ASME, and as the general chair, program chair and publications chair for the American Control Conference.

Included among Ulsoy’s professional honors and awards are the AACC 1994 O. Hugo Schuck Best Paper Award and the Southwest Mechanics Lectureship (1995), the 2001 ASME JDSMC Best paper Award and the ASME Dynamic Systems and Control Division Leadership (2000) and Outstanding Investigator (2004) Awards. Ulsoy served as the founding deputy director (1996-2002) of

the NSF Engineering Research Center for Reconfigurable Machining Systems, and has served as the director (1992-94) and associate director (1990-92) of the NSF Industry-University Cooperative Research Center for Dimensional Measurement and Control in Manufacturing.

Ulsoy has developed several new courses in the automatic control, automotive and manufacturing areas at U-M and is the co-author, with Warren R. DeVries, of the textbook *Microcomputer Applications in Manufacturing* (Wiley, 1989). He has also published more than 200 refereed technical articles in journals, conferences and books.

During a recent leave from U-M (2003-2005), Ulsoy served as the director of the Civil and Mechanical Systems Division of the National Science Foundation. That position gave him a good idea of how decision-makers in Washington view engineering and technology.

“A lot needs to be done to educate them on the importance of technology for the economy and the nation,” Ulsoy said. “I think membership in NAE will give me the opportunity to get involved in that.” He has already begun. In April he moderated a panel in Ann Arbor, sponsored by the NAE, on globalization and how it is affecting the auto industry.



# Jun Ni Honored with Sam Wu Professorship

Professor Jun Ni has been appointed Shien-Ming (Sam) Wu Collegiate Professor of Mechanical Engineering.



“This prestigious honor recognizes Professor Ni’s outstanding contributions to manufacturing science and engineering, his commitment to the pursuit of excellence in global research and educational programs, as well as his overall professional accomplishments and international stature,” said ME Department Chair Professor Dennis Assanis, in

announcing the professorship.

Ni received his B.S. degree from Shanghai Jiao Tong University and earned his MS and Ph.D. degrees from the University of Wisconsin-Madison in 1984 and 1987, respectively. In addition to being an ME professor, he serves as Dean of the U-M SJTU Joint Institute (see related story on p. 8) and director of the S. M. Wu Manufacturing Research Center. He also has served as the deputy director of the National Science Foundation (NSF) sponsored Engineering Research Center for Reconfigurable Manufacturing Systems and the co-director of the NSF-sponsored Industry/University Cooperative Research Center for Intelligent Maintenance Systems. From 1993 through 1998, he also served as the director of another NSF-sponsored Industry/University Cooperative Research Center for Dimensional Measurement and Control in Manufacturing.

Ni’s research and teaching interests are in the area of manufacturing science and engineering, with special focus on precision machining, manufacturing process modeling and control, statistical quality design and improvement, micro/meso systems and manufacturing processes, and intelligent monitoring and maintenance systems.

Throughout his career, he has published more than 200 archival technical journal and conference papers and book chapters. He has supervised 46 doctoral and 31 master graduates as a chair or co-chair. He has been responsible as a principal investigator or co-investigator of research projects worth more than \$35 million. Many of his research results have been successfully implemented in industrial applications at Boeing, DaimlerChrysler, Delphi, Ford, General Motors, Honda, Kelsey-Hayes, Perceptron, Saginaw Machine Systems and Tecumseh Products.

Included among his many honors and awards are the 1991 Outstanding Manufacturing Engineer Award from the Society of Manufacturing Engineers, 1994 Presidential Faculty Fellows Award by President William J. Clinton, 1999 National Natural Science Foundation of China’s Outstanding Oversea Scientist

Award and the 1999 Ministry of Education of China’s Cheung-Keung Endowed Professorship award.

## Professor Shien-Ming (Sam) Wu (Oct. 28, 1924 – Oct. 28, 1992)

Professor S. M. Wu was an internationally recognized leader and expert in manufacturing education and research. He was the Reid and Polly Anderson Professor of Manufacturing at U-M from 1986 until his death in 1992. In his three-decade professional career, he made unparalleled accomplishments to the field of manufacturing science and engineering. He was a pioneer who first introduced advanced statistical methods to manufacturing research since the 1960s. He developed a theory known as the Dynamic Data Systems and successfully applied it to diverse engineering and non-engineering fields. He published book chapters, textbooks and over 300 papers in scientific journals and conferences.



Wu mentored more than 125 Ph.D. students, close to 100 master’s graduates, and some 150 visiting scholars and post-doctoral researchers. His legacy has been continued through this large number of former students. Many of them are now in leadership positions in academia, industry and government worldwide. Beyond his significant impact to the academic side of the manufacturing community, he also had a profound impact on the manufacturing industry. Many of his ideas, concepts, and methods have been successfully implemented in manufacturing practice.

Included among his many honors and awards are the American Society of Mechanical Engineering Blackall Award (1968), Society of Manufacturing Engineers National Education Award (1974), the Fulbright Distinguished Professorship in Yugoslavia (1975), University of California Berkeley Springer Professorship Award (1979), ASME Russell Richards Award (1981), and the Chiang Manufacturing Achievement Award, Chiang Industrial Charity Foundation of Hong Kong (1991). He donated the entire \$100,000 from his Chiang Achievement Award to U-M to set up scholarship programs.

Wu was a graduate of Jiao-Tong University, Shanghai (1945); the University of Pennsylvania (MBA, 1956); and the University of Wisconsin-Madison (PhD ME, 1962). He was a faculty member at the University of Wisconsin for more than 25 years and was recruited to U-M to reestablish its manufacturing programs in 1987.

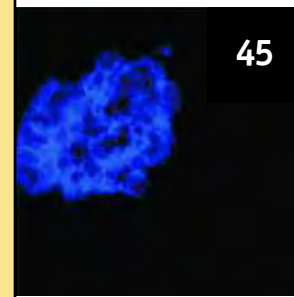

# ME Manufacturing Sets the Pace with Awards

Two ME professors have earned prestigious awards from the American Society of Mechanical Engineers (ASME) for their paradigm-shifting work in the field of manufacturing engineering. Professor Yoram Koren earned the M. Eugene Merchant Manufacturing Medal. Professor Jyotirmoy Mazumder earned ASME's 2006 William T. Ennor Manufacturing Technology Award.

Koren, who directs the National Science Foundation Engineering Research Center for Reconfigurable Manufacturing Systems (ERC-



RMS) at the University of Michigan, received the award for his outstanding contributions to the science, education and practice of manufacturing through innovations in

reconfigurable manufacturing systems, robotics and manufacturing system control, and for establishing reconfigurable manufacturing as a worldwide scientific discipline.

The M. Eugene Merchant Manufacturing award was established by ASME in 1986 to honor M. Eugene Merchant, an engineer who developed mathematical models for metal-cutting that had significant impact on manufacturing. Other work Merchant did led to the development of CAD, CAM and other manufacturing-related software. The award is

bestowed by ASME upon an individual of significant influence and responsibility, who has improved productivity and efficiency — through research or implementation of research — of manufacturing operations.

Like Merchant, Koren is a member of the National Academy of Engineering. Koren founded the ERC-RMS in 1996 and led its team of 100 researchers who hail from both academia and industry to create a new generation of reconfigurable manufacturing machines and systems. His work allows manufacturers to improve productivity and product quality, thereby cost-effectively facilitating the changes demanded by increased competition and globalization.



Koren teaches a course on global manufacturing (see story on page 11, "New Course and Textbook Make the Business Case for Responsive, Global Manufacturing"), which uses a draft of his new textbook, *The Global Manufacturing Revolution*. He holds 13 U.S. patents in the areas of manufacturing and robotics.

Mazumder, founding director of the U-M Center for Lasers and Plasmas for Advanced Manufacturing, holds the Robert H. Lurie Professorship in Engineering. He was recognized for "pioneering leadership in the

commercialization of laser-aided manufacturing, including the closed loop direct metal deposition process through which functional components can be made directly from the computer-aided design rendering."

The Ennor award is bestowed upon individuals who contribute significantly to an innovative manufacturing technology that results in substantial economic and societal benefit. It was established by ASME in 1990 with the Alcoa Company.

Mazumder, who is a professor of both Mechanical Engineering and Materials Science and Engineering, is credited with the commercialization of laser-aided manufacturing. He is known as a visionary and has built one of the world's most prominent university groups in laser materials processing. His work on the measurement and modeling of laser welding ushered in quantitative approaches for laser-aided manufacturing. His research on spectroscopic diagnostics of plasma associated with laser-aided manufacturing has led to the development of sensors and resulting improvements in process reliability.

The closed loop direct metal deposition (DMD) process that Mazumder invented has changed the way patient-specific bone tissue is grown; bio-mimetic scaffolds are made with DMD and genes are inserted in the scaffold to rapidly grow the tissue.

Mazumder is a fellow of the Laser Institute of America and the American Society of Metals. He won the Arthur Schawlow Award from the Laser Institute of America in 2003.



# Alan Wineman Receives Distinguished Faculty Achievement Award

Professor Alan Wineman earned a 2006 Rackham Distinguished Faculty Achievement Award from the University of Michigan for his significant contributions and dedication to teaching, research, service and mentoring.

Wineman joined the faculty of the College of Engineering in 1964. Over the years he has established an inimitable record of teaching excellence, with consistently high evaluation scores and a long list of honors: Pi Tau Sigma, the Mechanical Engineering Honor Society, named him Professor of the Term four times; he received the College of Engineering Teaching Excellence Award twice; he was named Arthur F. Thurnau Professor in 2000; and he earned the American Society of Engineering Education A. Higdon Award in 2002.

Wineman's commitment to teaching excellence is also evident in his participation in Center for Research on Learning and Teaching projects and symposia, attendance at the Stanford Institute on Peer Review of Teaching and participation in the College of Engineering Teaching Academy.

His research focus is the development and application of mathematical models of the mechanical response of polymeric solid and fluid materials (see story on page 33, "Insights Into Elastometric Deformation"). His work is widely published in top journals, and his doctoral dissertation on material symmetry restrictions on constitutive equations has become a standard reference in nonlinear mechanics of continua.



As a result of his work developing viscoelastic models that account for the damping characteristics of automotive bushings and his recent book, *Mechanical Response of Polymers*, Wineman is recognized worldwide as a leader in the mechanical response of viscoelastic materials. Colleagues say he is a creative and innovative researcher.

Wineman has been a part of numerous departmental, College and University committees. He has served on the board of directors of the Society of Engineering Science, organized many symposia at national conferences and co-organized several conferences held at U-M.

No matter how busy he is, however, Wineman makes time to mentor students — undergraduate and graduate — as well as junior faculty. Two of his former students, Drs. John A. Shaw and Susan Montgomery, now hold faculty positions in the College of Engineering. Wineman also serves as faculty advisor to the U-M Gilbert and Sullivan Society. He has performed with the group since 1981. "It's my secret life away from the University," he joked. "And it shows that I'm not a boring engineer."

*I was a sophomore undergraduate student in 1982 in Alan Wineman's Strength of Materials class (ME 211). I enjoyed the course so much that it arguably led to my career as a university professor in mechanics. He was an unforgettable character in class, and several of Alan's lectures remain in my memory. He always had a clear and simple explanation for hard-to-grasp concepts. He was a patient teacher with an engaging style, often humorous and often using everyday examples to make his point.*

—John A. Shaw, PhD, associate professor, Aerospace Engineering

*I was a student in Prof. Wineman's ME 211 class as an undergraduate. I was very impressed by how organized he was, how he laid out the information so clearly. Even as well as he obviously knew the material, he knew the problems beginners had with the subject and could speak to us at our level. He had a sense of humor that made me look forward to his classes, and it was clear that he cared about each of us individually. I learned a lot from him about treating students with respect and caring... He has been a role model in both my personal and professional lives.*

—Susan Montgomery, PhD, PE, lecturer and undergraduate program advisor, Chemical Engineering

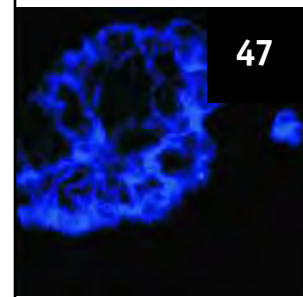

## Jwo Pan Named SAE Fellow

The Society of Automotive Engineers has named Professor Jwo Pan a fellow. Pan was one of 32 members who earned the designation in 2006. The membership grade of fellow honors those who have made a significant impact on society's mobility technology through research, innovation or creative leadership.



Pan, the industry has relied on technicians visually inspecting crankshaft fillets for the presence of bubbles, the tell-tale sign of fractures, during bending fatigue testing.

Pan and his students used finite element computations and experimental correlations to determine and validate the residual stresses near the

fillets and final failure of crankshafts. Their results indicated that the widely accepted four-bubble failure criterion is too conservative, and they have proposed new failure criteria. Based on Pan's theoretical framework, engineers at DaimlerChrysler have validated the new failure criteria experimentally and automated bending fatigue tests, saving significant labor costs and time.

In work supported by Ford Motor Company, Pan developed failure criteria for spot welds under combined loading conditions, which has been generalized for spot welds under dynamic complex, multi-axial loading

conditions for implementation into commercial finite element codes for crash simulations.

Ford will be incorporating the new criteria into product design in the near future, according to Pan. A German SAE spot weld committee is already using his analytical and computational solution to study spot weld fatigue. Currently Pan and his group are investigating the failure and fatigue mechanisms of friction spot welds in aluminum sheets based on different processing parameters for the auto industry.

Pan is a co-author of a book entitled *Fatigue Testing and Analysis* (Elsevier, 2005) and author of *Mechanics Modeling Sheet Metal Forming* (SAE, forthcoming).

He says he is honored to achieve the rank of SAE fellow. He is grateful to his industry co-investigators "for bringing me these difficult, unresolved engineering problems. I am happy that our rigorous approach to solving practical problems will have a long-term impact on engineering practices in the automotive industry."

Pan was recognized for his fundamental contributions to fracture mechanics, fatigue and plasticity theories that are critical to the design and manufacturing of sheet stamping, durability prediction, crash simulation, and spot weld fatigue and separation for the automotive industry.

He has recently developed failure criteria for automotive crankshafts. For many years the auto industry has been using deep fillet rolling to induce compressive residual stresses near stress concentration sites to increase crankshaft fatigue life. But too much rolling can lead to lower fatigue resistance. For at least the past 50 years, according to

## Hong Im Receives Ralph R. Teetor Award

Associate Professor Hong G. Im has earned the Society of Automotive Engineers (SAE) Ralph R. Teetor Award. The award is bestowed by the SAE Ralph R. Teetor Educational Fund to allow educators to interact with practicing engineers so that they can in turn inspire students to pursue careers in mobility engineering. Other recent Teetor Award winners in the ME department include Associate Professor Albert Shih in 2004; Associate Professor Anna Stefanopoulou in 2002; and Associate Professor Margaret Wooldridge in 2001.



who work on the research, design, development and production of land, sea, air and space vehicles.

Im has been involved in a number of research projects directly and indirectly related to the automotive industry, and often presents at SAE conferences. His research focus is on high-fidelity

computational modeling of laminar and turbulent reacting flows, with applications including internal combustion engines and micro-combustors.

"Recognition of my teaching and research activities by SAE is a great honor and a rewarding experience for me," said Im.

He anticipates that the Teetor Award will enhance the recognition and visibility of his research activities, which will open up further active collaborations for his research group with governmental and industrial organizations doing automotive research.

Many students outside his lab will benefit as well: "There are a number of graduate students in the ME department who aspire to pursue a career in the automotive industry," he said. "My increased participation in SAE activities deepens my knowledge in more practical aspects of my expertise. This will help me prepare my lectures with more up-to-date and practically relevant subjects and will guide me in future state-of-the-art research projects in modern internal combustion engines."

The Teetor Award program brings engineering educators to the annual SAE World Congress and Exposition in Detroit or the SAE AeroTech meeting held every other year. The events attract more than 45,000 engineers



# Krishna Garikipati Completes Humboldt Fellowship

Associate Professor Krishna Garikipati is completing a 16-month Humboldt Research Fellowship. The prestigious and competitive fellowships are given by the Alexander von Humboldt Foundation to promising scientists in early stages of their careers. A small number of senior scientists, typically having completed at least 20 years of work in a field, are considered for Humboldt awards.



and numerical methods for certain phenomena described by high-order partial differential equations.

At the University of Stuttgart, he has worked with Mieke to develop ideas about the microstructural basis for the mechanical response of soft biological tissues. The tissues are organized into chain-like structures at many spatial scales and bear resemblance to polymeric structures, he explained. Drawing on classical work on chain-like structures, Garikipati is exploring the appropriateness of entropic and energetic models for the elasticity of soft biological tissues, work he also does at U-M.

Additionally, at the Max Planck Institute in Stuttgart, Garikipati has collaborated with Professor Huajian Gao's group in the area of cell mechanics.

Garikipati spent his term as fellow at the University of Stuttgart, working with hosts Professor Christian Miehe and Professor Ekkehard Ramm. Miehe chairs the Institute of Applied Mechanics, and Ramm recently stepped down as chair of the Institute of Structural Mechanics.

Garikipati's work focuses on mathematical models for growth and remodeling of biological materials, the physics and mechanics of stress-defect interactions in semiconductors

The fellowship experience has been an extremely valuable one for Garikipati. "The reason I am in academics is that I like to think about the physics of interesting systems, how to describe them mathematically and compute solutions to problems involving these systems. The fellowship has given me an unparalleled opportunity to conduct unfettered research along these lines. I believe it will change my work in a qualitative manner."

## Ellen Arruda Named Centennial Fellow

Associate professor Ellen M. Arruda has been named a Centennial Fellow by the Pennsylvania State University Department of Engineering Science and Mechanics. The department is celebrating its 100th year in 2006.



The department selected Arruda an "outstanding graduate" and named her a Centennial Fellow because her professional accomplishments since she left her *alma mater* "have brought honor to the department." Arruda earned a bachelor's degree in Engineering Science and a master's degree in Engineering Mechanics from Penn State.

The designation of Centennial Fellow "recognizes a select group from among our alumni who lead our disciplines and professions in this centennial year," wrote Judith Todd, department chair. "The Centennial Fellows provide a benchmark of excellence as the department enters its second century.

Arruda earned her Ph.D. in mechanical engineering from Massachusetts Institute of Technology and joined the U-M Department of Mechanical Engineering in 1992. Currently she serves as an associate professor of both Mechanical Engineering and Macromolecular Science and Engineering.

Arruda studies the mechanical behavior of polymers, elastomers and soft tissue. Her lab has developed an *in vitro* model for collagen growth and remodeling studies in ligament and tendon. She also conducts computational simulations to test hypotheses related to soft tissue mechanics that are derived from experimental observations. Her research includes aging and disuse in tendon and the influence of loading on tendon and ligament ruptures. She also develops methodologies for testing polymers and elastomers used in high strain-rate applications, including automotive crashworthiness.

Arruda is no stranger to recognition. She earned an Outstanding Achievement Award in 2004 from U-M and a National Science Foundation CAREER Award in 1997. She has held numerous leadership positions, including president and vice president of the board of directors of the Society of Engineering Science.

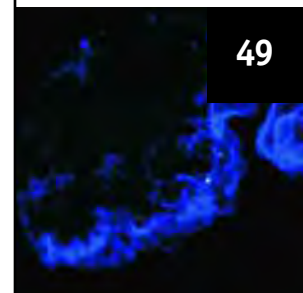

# Get to Know New ME Faculty

## Shorya Awtar



Shorya Awtar has joined the ME faculty as an assistant professor in January 2007.

Awtar earned his bachelor's degree in mechanical engineering from the Indian Institute

of Technology in Kanpur, a master's degree in mechanical engineering from Rensselaer Polytechnic Institute and his doctoral degree from the Massachusetts Institute of Technology. His areas of research and study include precision engineering, machine and mechanism design, mechatronics and motion systems. His dissertation involved the analysis and synthesis of parallel kinematic XY flexure mechanisms.

After earning his doctoral degree, Awtar worked for the General Electric Global Research Center on advanced sealing and actuation technologies for energy systems, such as turbines and aircraft engines. He has also been a guest scientist at the National Institute of Standards and Technology, where he worked on the design and assembly of metrology systems for precision flexure stages.

At U-M, Awtar intends to build upon his experience in precision engineering and conduct research in micro and nano positioning with applications such as nanomanufacturing, biomedical imaging, sensing and actuation. He is also interested in developing technology to advance robotic surgery and bionic prosthetics.

He will likely teach an undergraduate course in design, manufacturing, mechanics or dynamics and controls. At the graduate level, he plans to offer a course in multi-scale motion systems, precision machine design, or biomedical mechatronic systems.

Awtar says it was U-M's position as one of the top educational centers in the country that attracted him to his new job. "The University's academic prestige, world-class research facilities, distinguished faculty — U-M is

home to some of the most renowned academics in their respective fields — as well as students, and the friendly nature of everyone that I met during my interview, were all key factors in my decision."

## A. John Hart

A. John Hart has accepted a faculty appointment in the Department of Mechanical Engineering. He will assume the position of assistant professor in the summer of 2007.



Hart is no stranger to Michigan, as he grew up in Royal Oak — or to U-M, where he earned his bachelor's degree in ME in 2000. He went on to earn a master's and doctorate from the

Massachusetts Institute of Technology in 2002 and 2006 respectively.

His research focuses on nanostructured materials such as carbon nanotubes, particularly on design of instruments and methods for manipulating reactions to produce these materials, along with manufacturing processes for realizing the fantastic properties of these materials at macroscopic scales. He also works in the areas of precision machine design, microsystems, catalysis and energy conversion. John has earned numerous awards and honors, including the 2006 MIT Senturia Prize for Best Doctoral Thesis in Micro/Nano-technology; a Fannie and John Hertz Foundation Fellowship; a MIT Deshpande Center Ignition Grant; and a National Science Foundation Graduate Research Fellowship.

At U-M, Hart will initially teach an undergraduate design and manufacturing course, and he plans to develop a new class on the growth and processing of nanostructured materials.

Returning to U-M, he says, just amplifies the excitement about becoming a new faculty member. "Wherever you go, there's the challenge of starting your lab and teaching

and hiring students and doing everything in parallel. It's daunting, but I know I'll feel at home."

He is also looking forward to working with Shorya Awtar, who will be joining the ME department as well. The two were lab mates at MIT. Although their research areas differ, they worked together on a project to build "Magnebots," a system for automated material handling using autonomous overhead vehicles, and "would be excited to have a Magnebot cruising the halls of the G.G. Brown building."

## Kenn Oldham

Kenn Oldham has accepted the position of assistant professor of mechanical engineering. He will join the U-M faculty in September 2007.



Oldham earned his PhD in mechanical engineering from the University of California at Berkeley. His areas of study included controls, microfabrication and dynamics. Oldham's

dissertation, "Microdevices for Dual-Stage, Instrumented Vibration Suppression in Hard Disk Drives," focuses on the production of instrumented suspensions and electrostatic microactuators for hard disk drives. As a result, his doctoral work has included MEMS design and fabrication, sensor and actuator optimization for closed-loop system performance, sensor circuit design, microdevice installation and testing and robust controller development and evaluation.

Using microactuators and microsensors in computer hard disk drives to improve servo positioning and data storage capacity involves integrating MEMS devices into larger control systems. Oldham has built the first MEMS microactuator to be successfully flown in a disk drive by an academic group. His work paves the way for testing of new and novel servo control schemes.



Once he arrives at U-M, Oldham plans to explore in more detail how control systems interact with mechanical and system design and expects to continue his focus on micro-scale engineering applications.

In addition to continuing his research, Oldham will teach courses in dynamics and controls. As a graduate student instructor at UC, Berkeley, he led sections of an advanced controls course. He says he especially enjoyed a recent opportunity to work with middle school students to bring standards-based engineering project modules into the classroom to help teach science and math. He has also developed and taught pre-engineering curricula to local middle school students enrolled in summer engineering outreach programs.

“The opportunity to do research in an environment with fantastic resources in terms of students, other faculty members with a tremendous breadth of expertise, and excellent clean room facilities for micro-scale engineering,” are three reasons Oldham is excited about the U-M position. “I expect this to provide great flexibility in applying the ideas generated by my research to new applications.”

## Kathleen Sienko

Kathleen Sienko has joined the U-M faculty as assistant professor in the Department of Mechanical Engineering on January 1, 2007.

Most recently she served as a graduate research assistant at the Massachusetts Eye and Ear Infirmary.



Sienko’s research interests involve the design and development of medical devices. Her prior work has

focused on balance-related research for patients with vestibular deficits, the elderly and astronauts. This work has included developing metrics that quantify locomotor stability for diagnosis and characterization purposes and developing a noninvasive vibrotactile balance prosthesis to improve

postural and gait stability. At MIT she was involved in several startup ventures, including leading a team that developed a balance prosthesis that won the MIT \$50K Entrepreneurship Competition.

Sienko says that she was drawn to the University of Michigan because it is “one of only a few places that have both top engineering and medical schools, with a large pool of highly talented students.” In addition, she is excited by the “entrepreneurial spirit at the University of Michigan and the number of startups in Ann Arbor.” She is looking forward to collaborating with faculty and students in both the College of Engineering and the Medical School, and is planning an introductory course on medical device design and development.

“At U-M, I expect to pursue my research interests in several different contexts,” she said. These areas include the design and testing of wearable balance prostheses and rehabilitation devices for the balance impaired, the design and testing of MEMS-based implantable devices to augment or replace vestibular function and the study of the effects of long-duration spaceflight on locomotion.

She also plans to expand the scope of her work to include research into cardiovascular devices, affordable medical technologies for the developing world and biological sensors and sensing systems. She recently returned from spending several weeks in India, where she completed clinical rotations in cardiology, neurology, gastroenterology, pediatrics and community care medicine.

Sienko earned her bachelor’s degree in materials engineering from the University of Kentucky, her master’s degree from the Massachusetts Institute of Technology in aeronautics and astronautics, and her Ph.D. from the Harvard University - Massachusetts Institute of Technology program in Medical Engineering and Medical Physics.

# Faculty Honors & Awards

## Ellen Arruda

- Centennial Fellow, Pennsylvania State University, 2006

## Dennis Assanis

- Tau Beta Pi Professor of the Year, 2006

## James Barber

- Service Award, College of Engineering, University of Michigan, 2005

## Johann Borenstein

- Elevated to Senior Member, Institute of Electrical and Electronics Engineers, 2005
- “Best of Show” Award for Personal Odometry System demonstrated at the 2006 ANS Sharing Solutions Conference (with Lauro Ojeda), 2006

## Diann Brei

- Teaching Incentive Award, Department of Mechanical Engineering and Applied Mechanics, University of Michigan, 2006

## Matt Castanier

- Outstanding Research Scientist Award, College of Engineering, University of Michigan, 2005-2006

## Steve Ceccio

- Fellow, American Society of Mechanical Engineers, 2005

## Dragan Djurdjanovic

- Teaching Incentive Award, Department of Mechanical Engineering, University of Michigan, Winter 2005
- Best Paper Award in the Factory Operations section at the 8th Semiconductor Research Corporation (SRC) Technical Conference (TechCon), 2005

- Branimir F. von Turkovich Outstanding Young Manufacturing Engineer Award Society of Manufacturing Engineers, 2006

## Bogdan Epureanu

- Outstanding Achievement Award, Department of Mechanical Engineering, University of Michigan, April 2006

## Krishna Garikipati

- Alexander von Humboldt Foundation Fellowship, May 2005-August 2006

## Jack Hu

- Robert Caddell Faculty/Graduate Student Team Award (with Ph.D. student Guosong Lin), September 2005
- Research Excellence Award, College of Engineering, University of Michigan, 2006

## Hong Im

- Ralph R. Teetor Educational Award, Society of Automotive Engineers, 2006

## Reuven Katz

- Excellence in Teaching award (in two courses) from the Technion-Israel Institute of Technology student association, 2005

## Massoud Kaviany

- Hawkins Memorial Lecture Series (Heat Transfer), Purdue University, 2005

## Yoram Koren

- Merchant Gold Medal, American Society of Mechanical Engineers and the Society of Manufacturing Engineers, 2006

## Jun Ni

- Guest Professorship, Nanjing University of Science and Technology, 2005
- Best Paper Award, SRC TECHCON 2005

- Shien-Ming (Sam) Wu Collegiate Professor of Manufacturing Science, University of Michigan, 2006-2011

## Lauro Ojeda

- “Best of Show” Award for Personal Odometry System demonstrated at the 2006 ANS Sharing Solutions Conference (with Johann Borenstein), 2006

## Jwo Pan

- Fellow, Society of Automotive Engineers, 2006

## Noel Perkins

- Academic Challenge Award (for invention of fly casting analyzer), Technical University of Munich and ISPO, 2005

## Volker Sick

- Outstanding Student Group Advisor Award, CoE Epeians, 2006

## Steve Skerlos

- Education Excellence Award, University of Michigan, 2006
- Elaine Harden Award for BlueLab, 2006

## Galip Ulsoy

- National Academy of Engineering, October 2006
- Outstanding Achievement Award, Department of Mechanical Engineering, University of Michigan, 2006

## Alan Wineman

- Fellow, American Society of Mechanical Engineers, 2006
- Distinguished Faculty Achievement Award, University of Michigan, October 2006



# Epureanu, Ulsoy Earn Outstanding Achievement Awards

Assistant Professor Bogdan Epureanu and Professor A. Galip Ulsoy earned Outstanding Achievement awards from the ME department for their significant contributions to the area of dynamics, systems and controls.



Epureanu explores non-linear dynamics and fluid-structure interactions in cutting-edge applications such as structural health monitoring, aerodynamics and aeroelasticity, computational and bio-dynamics. For example, he has developed a novel concept, nonlinear feedback excitation, to interrogate with high performance dynamical systems. This innovative method can increase the

sensitivity of sensors or damage detection by two orders of magnitude. Working with a colleague, Associate Professor Edgar M yhofer, he developed an original and advanced mechanistic model of the cooperation of molecular motor proteins, such as kinesin.

Epureanu has received an NSF CAREER Award, the American Academy of Mechanics' 2004 Junior Achievement Award, the 2003 ASME-Pi Tau Sigma Gold Medal Award and the ASEE 2004 Outstanding New Mechanics Educator Award. He recently completed a summer faculty research program at the Air Force Research Laboratory at the Wright-Patterson Air Force Base. He serves as faculty advisor of Pi Tau Sigma and conducts outreach activities with the Ann Arbor Hands-On Museum.

Of the Outstanding Achievement Award Epureanu said, "I was deeply honored to be a co-recipient with Professor Ulsoy — I hold him in such high esteem. I was also surprised to be

chosen. There are so many fine researchers and teachers in the department, so it means that much more to me."

Ulsoy's research centers on the adaptive control of machining operations and the modeling and theory of axially translating elastic materials. His group also developed the first theoretical modal analysis of rotating shafts.

Ulsoy, who has been on the U-M faculty since 1980, was the founding deputy director of the NSF Engineering Research



Center on Reconfigurable Manufacturing Systems. He is credited, along with colleague and ME Professor Yoram Koren, with developing the concept of reconfigurable manufacturing systems. Their papers on the subject are widely cited.

Ulsoy, currently the William Clay Ford Professor of manufacturing, has earned several best paper awards and has advised over 30

PhD students. He founded the College's Program in Manufacturing and has served in nearly every leadership role within the department, including as chair from 1998 to 2001. He has served as a leader off campus as well, most recently as director of the NSF's Civil and Mechanical Systems division. He was inducted into the National Academy of Engineering in October 2006 (see story on page 44 "Galip Ulsoy Elected to NAE").

Honored by the Outstanding Achievement recognition, Ulsoy said it is "rewarding to see that the basic work we do gets used and has an impact on engineering practice and the economy."

## Faculty Promotions

**Suman Das**, to Associate Professor with Tenure

**Krishnakumar Garikipati**, to Associate Professor with Tenure

**Karl Grosh**, to Professor with Tenure

**Katsuo Kurabayashi**, to Associate Professor with Tenure

**Albert Shih**, to Professor with Tenure

**Steven Skerlos**, to Associate Professor with Tenure

**Anna Stefanopoulou**, to Professor with Tenure

## Donors

Advanced Heat Transfer  
Albrecht, Terry Erwin  
Andrah Foundation  
Applied Engineering & Technology Integration, Inc.  
Assanis, Dennis and Helen  
Boltinghouse, Gary Lee  
Bongort, Kenneth J.  
Brownson, Keith R. Trust  
Caddell, Doris N.  
Carey, Daniel J.  
Caterpillar  
ChevronTexaco  
Coherix Inc.  
Cousino, Daniel and Heather  
DaimlerChrysler  
Dow Chemical  
ECO Cath-Lab Systems Inc.  
Erway, Timothy M.  
Exxon Mobil Corporation  
First, Sara Babcox  
Fisher, Mrs. Paula D.  
Ford Motor Company  
General Motors Corporation  
Gerich, Jerry W.  
Graebel Family Trust  
Gromax Enterprises Corporation  
Gyrus Medical  
Haberman, Dr. and Mrs. Robert C.  
Heatcraft Advanced Heat Transfer  
Henkin, Dr. Alexander  
Hogan, Shirley Mirsky  
Hovingh, Jack  
Hyundai Motor Company  
Ickes, William K.  
ITRI International Inc.  
Johnson & Johnson  
KAIST  
Kannatey-Asibu, Elijah  
Kenworthy, James  
Kids in Danger  
Kleveland, Dr. and Mrs. Andrew  
Kohlmeyer, Frederick and Faye  
Korybalski, Michael and Phyllis  
Lawrence Livermore National Laboratory  
Lockheed Martin  
Lunchini, Dr. and Mrs. John  
Martelli, Robert and Nancy  
McElwee, Mark R.  
Medtronic Foundation  
Mitchell, Frank J and Camilla  
National Instruments  
Nobunaga, Brian N.  
Papalambros, Panos and Lynn  
Proctor and Gamble Fund  
Purtill, Mary-Anne  
Schildcrout, Douglas and Abigail  
Schlumberger Technology Corporation  
Shell Oil Company  
Topspins Inc.  
Ulsoy, Galip  
Wilcox, Mr. and Mrs. Raymond I.  
Winer, Ward O.  
Yamatake Corporation

## Research Sponsors

Advanced Heat Transfer LLC.  
Agriculture, Department of  
Argonne National Laboratory  
Autospect, Inc.  
Boeing Company, The  
Caterpillar, Inc.  
Central Intelligence Agency  
Commerce, Department of  
Daihatsu Co. Ltd  
DaimlerChrysler Corporation  
Defense, Department of-Air Force  
Defense, Department of-Army  
Defense, Department of-Defense Advanced Research Projects Agency  
Defense, Department of-Navy  
Delphi Automotive Systems  
Dow Chemical Company  
Dynax Corporation  
Eaton Corporation  
Eco Cath-Lab Systems, Inc. (ECLS)  
Energy, Department of  
Environmental Protection Agency  
ETAS, Inc.  
Ford Motor Company  
General Electric Company  
General Motors Corporation  
GEO-Centers  
Health and Human Services, Department of-National Institutes of Health  
Honda R & D Company, Ltd.  
Johnson & Johnson  
Johnson Controls, Inc.  
Keck, W. M., Foundation  
Korea Institute of Energy Research (KIER)  
Korean Automotive Technology Institute (KATECH)  
Michigan, State of, Michigan Economic Development Corporation  
Minnesota Mining and Manufacturing Company  
Modbus Organization, Inc.  
National Aeronautics and Space Administration  
National Instruments  
National Science Foundation  
Nissan Motor Company  
Pilz Automation Safety  
Ping Golf  
Semiconductor Research Corporation  
Solidica Inc  
Spinal Cord Research Foundation  
The LEV Group, LLC  
Toyota Motor Company, Ltd.  
Toyota Technical Center, USA, Inc.  
TRW Foundation  
Visteon  
Volvo Car Components Corporation  
Whirlpool Corporation



# William W. Schultz Appointed to NSF Post

**P**rofessor William W. Schultz has been appointed director of the Fluid Dynamics and Hydraulics (FDH) program of the National Science Foundation. The program falls under the auspices of the division of Chemical, Bioengineering, Environmental, and Transport Systems (CBET) of the NSF's Directorate for Engineering.



The program Schultz will direct beginning fall 2006 supports fundamental research into the mechanisms governing fluid flow phenomena. As program director, Schultz will primarily oversee grant programs for university faculty in the United States. Research funded by the program includes four major areas of fluid flow phenomena: hydrodynamic stability, turbulence and flow control; rheology, polymers and complex fluids; micro-, nano- and bio-fluid dynamics; and waves, hydraulics and environmental fluid mechanics. He also expects to get involved in related activities in engineering education and serve as an international liaison.

Michael Plesniak, immediate past program director of FDH and a professor of mechanical engineering at Purdue University,

and John Foss, a professor of mechanical engineering at Michigan State University and Plesniak's predecessor, both recommended Schultz for the two-year position.

Schultz says he is most looking forward to "learning which research areas are hot, and since I'll be interacting with other federal funding agencies I'll know a lot more about the ins and outs of funding. I'm also looking forward to working with all sorts of other programs to fund joint projects."

At U-M, Schultz has several joint, ongoing research projects of his own (see story on page 27, "Dowling, Schultz Develop Washing Machine Simulations"). "I'll be coming back [to Ann Arbor] every few weeks to meet with the co-investigators and the students I'm advising, plus we'll have day-to-day email and phone contact, so all of my research will continue," he said.

Schultz is also enthusiastic about spending two years in the nation's capital. "I spent one summer in Washington, D.C., and that was 20 years ago with a young family. As empty nesters now, we're looking forward to experiencing the city in a different way. All of the previous directors and colleagues from the ME department who've lived there say it was a wonderful experience and an exciting place to be."

---

# Professor Michael M. Chen Retires

**T**he Board of Regents of the University of Michigan has named Michael M. Chen professor emeritus of mechanical engineering. Chen retired from his faculty position as professor in the ME department on December 31, 2005 after 15 years of service.



Chen's scholarship explored the thermo-fluid scientific disciplines of fluid mechanics, heat transfer, thermodynamics, applied mathematics and numerical analysis. He applied the principles of these disciplines to myriad engineering problems, including melting, welding, radiation, optics, biological systems, transport in fluidized beds and porous media. His investigations involved both theoretical and experimental work, conducted at a level of unusual depth and breadth, say colleagues. He developed a new numerical

method for solving two-phase moving boundary problems, and he is completing a book about convection heat transfer that sets forth his methodology for formulating and solving related problems.

Chen has written two other books, ten book chapters, more than 70 papers and 80 conference publications. He was elected a fellow of the American Society of Mechanical Engineers, and he earned the organization's prestigious Heat Transfer Memorial Award. Students remember him as a kind, caring teacher and mentor. Colleagues often sought his counsel on matters both personal and professional.

Prior to joining the U-M faculty, Chen served as professor at University of Illinois at Urbana-Champaign from 1973 to 1991. He also held prior faculty positions at Yale University and New York University. He earned his bachelor's degree from University of Illinois in 1955, his master's degree from Massachusetts Institute of Technology in 1957 and a doctorate, also from MIT, in 1961.

# Staff Complete 40 Years of Service

2005 marked the 40th anniversary of three talented and dedicated ME staff members: Lynn Buege, Sue Gow and Arlene Schneider

## Lynn Buege



Lynn Buege, mechanical engineering senior supervisor, has never shied away from tough work assignments around the University. He has assembled analog computers, built test stations to

gauge the energy necessary to fragment bone and devised a power supply system for retinal cameras.

Buege joined the ME department in 1968. "I had been looking for a position to satisfy my desire for more challenge and further education, and this was an ideal situation."

Buege served as an Engineer III for most of his career and now supervises and mentors eight technical personnel. He oversees the operation of the machine shop where he and his staff, often using numerical machine tools, produce unique components and repair ME equipment.

Buege earned a Staff Excellence award in 1992. He also developed and taught an elevator maintenance course for the University's Plant department. Buege's favorite memories are less about his jobs than about the people with whom he works. "I have been able to accomplish great things because I have been fortunate enough to be part of a superior team: my supervisors, co-workers and the people I supervise," he said. "I am extremely dependent on these people, and they make me look good."

## Sue Gow



Sue Gow, undergraduate student advisor in the Academic Services Office has done and seen a lot in her 40 years with the University.

Gow began as a clerk in the

hospital's Cancer Research department when she was 17. From there she moved to the Personnel department, then to Central Campus and — for the next 15 years — Rackham Graduate School, where she was promoted to Supervisor of Records.

Despite meeting Presidents Ford and Carter, boredom eventually set in. "I was happy at Rackham, but it was time for new challenges," she said.

Gow was hired in 1984 as the ME department's first and only undergraduate student advisor. She helps new advising staff acclimate to the College by answering questions, staying heavily involved in many aspects of College policy and practices that relate to undergraduates and provides much 'history' about how things have evolved.

"But the real satisfaction comes from being able to help students," she said. "When a student overcomes academic problems and goes on to be successful, it makes the work all worthwhile."

She has advised 4,963 students from their sophomore year through graduation. By 2007 three of her former charges will have returned to the Department as faculty.

## Arlene Schneider



Arlene Schneider's first job at U-M was truly her first job. She was hired in January 1965 as a clerk in the Transcript department. "I was extremely excited," she said, "because it was

my first 'real' job. I wanted to work for the University because it offered so much: a great learning environment, salary, benefits, and it was fairly close to home."

Schneider went on to become a secretary for the assistant director of the Dietetics department. She also held secretarial positions in Hospital Administration at the University of Michigan Medical Center and C.S. Mott Children's Hospital.

Schneider joined the ME department in July 2000. "It was an opportunity to see the academic and research side of the University that I had not experienced, and it was also a chance to learn new skills."

As a senior secretary, she has worked in the Automotive Research Center, providing secretarial assistance to the administrative and financial office, coordinating the ARC Seminar Series, assisting with the annual ARC conference and providing secretarial assistance, as needed, to faculty, students and staff of the Optimal Design Lab.

Schneider retired from U-M in 2006.



# Marcy Brighton Chosen as Finalist for Distinguished Staff Service Award

**M**arcella (Marcy) Nautsch Brighton, ME department manager, was chosen as a finalist for the University of Michigan Workplace 2006 Distinguished Service Award. The award honors a University staff member who “has demonstrated outstanding leadership, vision and initiative.”

Brighton, who joined the University staff in 1987, has served as the ME department’s administrative manager since 2000. She was nominated for the award for her “commitment to excellence; dedication to service; thorough understanding of the job; measured, steady and fair way of dealing with people, and her ability to seize every opportunity to teach and share her knowledge.”

“You have to really listen and understand what the issues are and what people need. Then you have to solve their problem — or help them solve it — and try to offer alternatives that will achieve a solution,” she said. “I’m often in the position of telling faculty that they cannot do what they want due to a regulation or policy, but I always try to be logical in explaining why, and I try to offer alternatives.”

When Brighton was hired for her position by Professor Galip Ulsoy, then chair of the Department, she recalls him telling her that she would “never be bored” in the job. “That has been so very true!” she said. “There are always new problems to be solved or questions to answer, and I find myself continually learning from these challenges.”

“Marcy’s contributions to the ME department will be dearly missed,” said ME Department Chair and Professor Dennis Assanis. “During her more than six years in her current position, Marcy has been committed to excellence and provided dedicated service to our Department and the College.”

Brighton’s management philosophy and style have served her extremely well; she has brought about significant change within the Department in just a few years. “I am very proud of the staff environment that has evolved under my



Dennis Assanis, Marcy Brighton and Marjorie Lesser

stewardship,” she said. When she started the job, staff turnover was high and morale low. “I spent most of my first six months in the job communicating with staff and assessing the environment, that is, identifying and prioritizing the issues that would need to be resolved.”

She identified staffing needs and implemented a thorough interview and selection process that would result in the recruitment of high-quality employees. She also developed an orientation and training process that involves multiple people and ensures that expectations of supervisors and the department are clearly communicated to those who are newly hired. The programs and processes she put in place emphasize promotion from within and professional development for staff that addresses not only the skills required by their current position but their next job as well. “We are now running effectively with a staff cohort that is better trained and fewer in number,” she said.

Despite the challenges of the job, Brighton says the reward is great: “There is a lot of personal satisfaction in doing a good job, helping others achieve their goals and having all of this contribute to the outstanding reputation of ME.”



ME faculty and staff bid farewell to Marcy Brighton.

# MRacing Team Takes Third



The 2005-2006 MRacing team with its Formula car.

The 2005-2006 year went out with a win for the MRacing team: the group placed third in the Formula SAE® competition. Held at the Ford Motor Company Proving Grounds in Romeo, Michigan, in May, the event tested the mettle of some 120 university Formula SAE racing teams from around the world.

The MRacing team's vehicle is a 420-pound Formula-style racecar that uses a 600 cc motorcycle engine. About 70 percent of the car's parts are one-of-a-kind — designed, manufactured and tested by U-M students, explained Daniel Campbell, the 2006 MRacing team captain and project manager.

The U-M vehicle is unique among its competitors, he added. Its low weight was attained by using aerospace materials in conjunction with weight-minimized designs. An advanced traction control system used vehicle performance parameters to reduce wheel slip through corners and straights. And custom dampers, a senior design project that minimizes tire and road load variations, were "a must" for sound suspension design, he said.

The team cars are judged in a series of static and dynamic events over the course of four days. Events include technical inspection, cost, presentation, engineering design, solo performance trials and high performance track endurance.

The U-M win was the result of several factors, said Campbell, in addition to its innovative technical specs. "Group members were willing to learn, and we had the strong support of sponsoring companies and the College. The result was a racecar that was lightweight and its operations reliable and well understood."

Not that there weren't a few suspenseful moments. "To do well at competition a team must finish the endurance event.

The entire 30 minutes of the event is a nail-biting session," he said. "About 50 percent of the cars don't finish — most drop out due to engine problems." The U-M vehicle didn't experience any trouble, although a driver accidentally flipped a switch in the cockpit while driving. "This caused the car's engine to momentarily sputter. Everyone gasped but then quickly sighed with relief."

The team also won the Spirit of Excellence Award, which goes to the top three finishers. "This is our best finish since 1994, so we're all very excited," said Campbell. As a result of the podium finish, the team was invited and sponsored by the International Federation of Automotive Engineering Societies to attend the Japan Formula SAE race. The team won the following nine awards during the events held on September 13-16 at Ogasayama Sports Park, Japan: third Place, Formula SAE of Japan, FISITA World Cup and Godd Frame Design Award; Governor of Shizuoka Prefecture Award; first place, Spirit of Static Event Award and Design Award; second place, Presentation Award and Autocross Award; sixth place, JAMA Chairman Award.

The greatest incentive for students to participate on the MRacing team is "the unique opportunity that it provides to learn," said Campbell. That opportunity is greater now, thanks to a new course, FSAE Tech Elective (ME499), to be offered in Fall 2007. Active team members will be able to earn credit for approved vehicle-related projects.

Fame may be one more incentive now, too: *Road & Track* included the MRacing team in the magazine's own competition among the five most dynamic cars from the Detroit FSAE event in 2005. The *R&T* test was featured in the November 2005 issue.



# Undergraduate Student Honors & Awards

## **Axel Marin Scholarship**

Stephanie Beck

## **Benjamin S. Tuthill Scholarship**

Elobuike Oji

## **BP America**

Kenya L. Agee

Muhammad Anwar

Brian Boss

## **Carl A., Jr. and Isabelle M. Brauer Scholarship**

Mark Ang

## **Carl T. Doman Memorial Fund**

Robert Middleton

## **Carlos R. and Gloria W. Bell Scholarship**

Ryan Kottenko

## **Caterpillar Foundation**

Adam Lovit

Karan Seth

## **Chang Fund**

Brian Loeffler

## **Clarence E. Groesbeck Memorial Scholarship**

Robert Knaus

David Platt

Matthew Williams

## **Class of 1931E Scholarship**

Michael Bohn

Connor Henley

Alisyn Malek

Paul Sarantos

## **Class of 1934E Scholarship**

Bryan Hart

## **Class of 1939E Scholarship**

Patricia Pacheco

## **Class of 1948E Scholarship**

John Czoykowski

## **CoE Dean's Discretionary Funds**

Rennel Melville

## **CoE General Funds**

Felix Antwi

Bronson Edwards

Rennel Melville

Daniel Perez

Patrick Quigley

Jason Riggs

Ralph Sudderth

Stefanie Theis

Miesha Williamson

## **CoE Gift Funds**

John Stepowski II

Katherine Beiting

Daniel March

Muhammad Anwar

Robert Middleton

## **Cornelius and Margaret Donovan Scholarship**

Douglas Backinger

Christopher L. Liang

## **DaimlerChrysler Corporation Fund**

David Ohrin

Hamed Bazaz

## **David Aspland Scholarship**

Miesha Williamson

Jason Moscetti

Iyabo Williams

## **Delphi Automotive**

Theresa DeVree

Jason Moore

## **Donald and Lucille Malloure Scholarship Fund**

Kevin Lintjer

## **Donald B. Kennedy Engineering Scholarship**

Corwin Holmes

Nicholas Lynn

## **Donald G. Gilbert Scholarship Fund**

Kenya L. Agee

## **DTE Energy Endowed Scholarship Fund**

Jennifer Sanch

## **Edward H. Strohm Scholarship in Engineering Fund**

Benjamin Hagan

## **Eli Lilly & Company Foundation**

Brian Schielke

Karan Seth

## **F. Ernest Newbery Scholarship Fund**

Vanita Mistry

## **General Motors Foundation**

Kenya L. Agee

Kelly Bryan

Kristin Cermak

Ian Hanna

Lindsay Klick

Patricia Pacheco

Ruey-Khan Tsang

## **Guidant Foundation, Inc.**

Andrew Mansfield

Jonathan Quijano

## **Haig P. Iskenderian Engineering Scholarship**

Christopher Vickery

## **Harriet Eveleen Hunt Scholarship Fund**

Makram Debbas

## **Helen M. Arens Scholarship**

Steven El Aile

Raymon J. Galle

Matthew Momon

Elizabeth Tappan

## **Howard W. and Ruth Hoff Sheldon Scholarship**

Nathan Cross

Brandon Geiger

Brian Weinbaum

Aaron Williams

Frederica Yawson

## **James A. and Judith McDivitt Scholarship**

Raymond Smith II

*continued* ▶

## Undergraduate Student Honors & Awards continued

### John C. Seeley Memorial Scholarship

David Ohrin

### John Deere Foundation

Kenya L. Agee  
Beth Bezaire  
David Krumanaker

### John Hart Scholarship

Rebecca Stoloff

### Joseph B. and Florence V. Cejka Scholarship

Jeremy Collins

### Joseph Boyer Scholarship

Jeffrey Martinez

### Ken K. Kohrs Scholarship Fund

Dennis Lee

### Lawrence D. Corlett Scholarship

David Ohrin  
Evan Quasney

### Matthew J. Spence, Jr. and Sarah Patterson Spence Scholarship Fund

Milan Paunovic

### May L. Lafever Scholarship

Merry Shao

### Michael E. Korybalski Endowment Fund

David Baron  
Rory Fraga

### Michigan Engineering Fund

Kelly Bryan  
Elizabeth Coon  
Ryan Mack  
Jason Spenny  
Paul Smith  
Joshua Titus

### Paul C. and Ruth M. Robertson Fund

Robert Halgren

### Pearl Wheeler Scholarship in Engineering

Paula Harrison

### Ray W. and Mary Lou Judson Scholarship

Jessica L. Katterheinrich

### Richard Earhart Scholarship

Steven LaForest

### Robert D. Holbrook Scholarship

Stephen Jeske

### Shell Oil Company Foundation

Jason Call  
Elliot Harik

### Simon Mandlebaum Scholarship Fund

Bronson Edwards

### The Boeing Company

Amul Sathe

### Walter G. Mitchell Memorial Scholarship

Scott Cackowski  
Kristina Tolbert

### Walter Graves Scholarship

Nicholas Sochacki  
Ryan Stevens  
Sijia Yang

### William E. Bandemer Scholarship

Emily Marks  
Michael Rayle  
Matthew Savoy  
Jacob Temme

## Graduate Student

### RACKHAM

**2005 Distinguished  
Dissertation Award**  
Yi-Chung Tung

**2005/06 International Student  
Fellowship**

Abhishek Yadav

**2006/07 Predoctoral Fellowship**  
Xiulin Ruan

**2006/07 Predoctoral Fellowship**  
Shih-Hsun Yin

**2005/06 Non-Traditional  
Fellowship**  
James Beyer

**2005/06 Non-Traditional  
Fellowship**  
Robert Dodd

### REA I Fellowship

Paul Arias  
Ethan Daley  
Carlos Perez  
Evan Pineda  
Roberto Torres

### REA II Fellowship

Tanna Borrell  
Julianna Evans  
Stephanie Frangakis  
Ying Jin  
Sara Wilhoit  
Sara Young

### Recruitment Fellowship

Ram S. Athreya  
Matthew Chastagner  
Jinli Feng  
Mark Gordon  
Yang Lin  
Elliott Morrison-Reed

### COLLEGE

### Deans/Named Fellowship

Gaurav Bansal  
Jishnu Bhattacharya  
Gabriel Lavella  
Mark Pankow  
Benjamin Reedlunn  
Steve Shrader



# Honors & Awards

## Regents Fellowship

Yun Ju Lee  
Paul Teini

## Distinguished Achievement Award

Karim Hamza  
James Smith

## Distinguished Leadership Award

Kiran Dsouza  
Danese Joiner  
Erin MacDonald

## Harry Benford Award

Ahmir Rashid

## Center for the Education of Women (CEW) Ford Motor Co Fellow

Edna Kollarits  
Diana Ma

## EXTERNAL

### Ford Foundation Diversity Fellowship

Roberto Torres

### National Consortium for Graduate Degrees for Minorities in Engineering and Science (GEM) PhD Fellowship

Danese Joiner  
Scott Norby-Cedillo

### Department of Energy (DoE) Naval Nuclear Propulsion Fellowship Program

Alexander Mychkovsky

### Homeland Security Fellowship

Robert Littrell  
Gregory Sommer  
Steven Truxal

### National Science Foundation (NSF)

Kiram Dsouza  
Danese Joiner  
Troy Lionberger  
Erin MacDonald  
Sara Young

### Microsystems and Engineering Sciences Applications (MESA)

Troy Lionberger

## DEPARTMENT

### Department Fellowship

Michael Chin  
Naveen Gupta  
Yongqing Li  
Buzz McCain  
Chandresh Mehta  
Liang Zhou

### Ivor K. McIvor Award

Sachin Goyal  
Pai-Chen Lin

### Robert M. Caddell Memorial Award

David Salac

## ENGINEERING GRADUATE STUDENT SYMPOSIUM AWARDS

### Dynamics, Systems, and Controls

#### Oral Session - 1st place

Andreas Malikopoulos

#### Oral Session - 2nd place

Kevin King

#### Poster Session - 1st place

Tulga Ersal

#### Poster Session - 2nd place tie

Kevin King

#### Poster Session - 2nd place tie

Andreas Malikopoulos

### Design and Manufacturing

#### Oral Session - 1st place

William Ross Morrow

#### Oral Session - 2nd place

Erin MacDonald

#### Oral Session - 3rd place tie

James Allison

#### Oral Session - 3rd place tie

Shingo Takeuchi

#### Poster Session - 1st place

Erin MacDonald

### Fluid Mechanics and Heat Transfer

#### Oral Session - 1st place tie

James Smith

#### Oral Session - 3rd place

Rui Zhang

#### Fluid Mechanics and Heat Transfer - Poster Session - 1st place

Baoling Huang

#### Fluid Mechanics and Heat Transfer - Poster Session - 2nd place

Gi Suk Hwang

#### Fluid Mechanics and Heat Transfer - Poster Session - 3rd place

James Smith

### Solid Mechanics

#### Oral Session - 1st place

David Salac

#### Oral Session - 3rd place tie

Xuan Tran

#### Oral Session - 3rd place tie

Kyoo Sil Choi

#### Biomedical Engineering Poster Session - 1st place

Szushen Ho

#### Poster Session - 2nd place

Todd Lillian

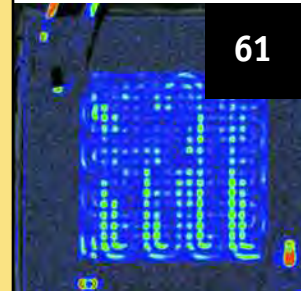

# ME Graduates Receive Faculty Appointments

## Aris Babajimopoulos



**Assistant  
Research  
Scientist  
U-M  
Department of  
Mechanical  
Engineering**

Aris Babajimopoulos (PhD ME '05) joined the U-M

Mechanical Engineering faculty in January 2006 as an assistant research scientist in the W.E. Lay Automotive Laboratory.

Babajimopoulos' main research interest is homogeneous charge compression ignition, or HCCI. During his doctoral work he developed a methodology for modeling HCCI combustion using computational fluid dynamics and a multi-zone chemistry solver with detailed chemical kinetics. He has also investigated the mixture formation process in HCCI engines, particularly in cases where advanced valve timing techniques, such as negative overlap or re-breathing, are used to trap large amounts of hot, residual gases.

Currently he is investigating the potential of a free piston linear alternator, which directly converts chemical energy from fuel into electricity, as a viable, cost-effective option for use in a series hybrid electric vehicle. The new project is funded by General Motors and involves the development of computational models characterizing the entire vehicle system. The models are then used to evaluate and optimize overall system performance.

Babajimopoulos completed his graduate studies at U-M as well as a post-doctoral research fellowship. "Being a member of such an outstanding research team and interacting with brilliant professors, researchers and students has been the greatest learning experience," he said. In addition, "being close to Detroit and the automotive industry and working closely with their R&D groups provide ideal conditions for conducting research that is both relevant and cutting-edge."

## Hosam Fathy



**Assistant  
Research  
Scientist  
U-M  
Department of  
Mechanical  
Engineering**

Hosam Fathy (PhD ME '03) assumed the position of

assistant research scientist in U-M's Department of Mechanical Engineering in May 2006.

After earning his doctorate, Fathy worked with Emmeskay, Inc., as a consultant in the automotive R&D industry. In that role he helped develop models and modeling tools for automotive system design and hardware-in-the-loop simulation. He returned to U-M to pursue postdoctoral studies in 2004. "It was amazing while I worked in industry how much of the material we were building on came out of U-M," he said.

Fathy is now the associate director of Professor Jeffrey Stein's Automated Modeling Laboratory, where he develops algorithms that simplify dynamic system model development. His work has been applied to automotive systems, including power trains and vehicle dynamics. He also uses these modeling tools for engine-in-the-loop simulations conducted by Prof. Zoran Filipi's and Prof. Dennis Assanis's teams in U-M's Automotive Research Center.

In earlier doctoral work with Professors Panos Papalambros and Galip Ulsoy, Fathy optimized the design and control of a system simultaneously and applied his algorithms to passive and active vibration attenuation in elevators and automobile suspensions. As a graduate student he worked at The United Technologies Research Center (UTRC, Otis Division) and with Ford's Scientific Research Laboratory.

Fathy is glad to be back at U-M. "One thing I always found impressive about U-M is the quality of the students. There's an

atmosphere here of camaraderie and competition, which makes it very stimulating. Another nice thing is how many people at any given time are working in any given area and the number of perspectives they have. You can learn so much just by going to the seminars on campus; it's like a perpetual conference."

## John Ferris



**Associate  
Professor  
Virginia  
Polytechnic and  
State University**

John Ferris (PhD ME '95; MS ME '92) joined the faculty of Virginia Polytechnic and State University in August 2005 as an

associate professor in the Department of Mechanical Engineering.

Prior to his position at Virginia Tech, Ferris worked as a senior technical specialist in Advanced Chassis Development at ZF Technologies in Northville, Michigan, where he developed a virtual proving ground. His research program involved developing a high-fidelity, in-vehicle, road data acquisition system, including vehicle sensors and MEMS, analog signal conditioning and digital signal processing.

During his time at ZF Technologies, Ferris mentored graduate students from Europe completing their internships. He also taught technical seminars on ride quality perception, performance and vehicle handling and tire dynamics.

Ferris says he was drawn to the Department of Mechanical Engineering at Virginia Tech, "because they integrate classroom theory and practical hands-on experience. They conduct original research in vehicle systems and safety and believe in strong partnerships with both government and industrial partners." It's a "perfect fit," he added, "for my background in academia and industry."



During his first year at Virginia Tech, Ferris created and taught a new graduate class, Stochastic Processes. He also revised and taught another graduate course, Digital Signal Processing. As a new faculty member he is focused on building research partnerships with members of government, the military and the automotive industry.

Ferris' research goal is to establish the Vehicle Terrain Performance Laboratory as a world-recognized laboratory for improving vehicle system performance by studying the interactions between vehicles and terrain — both on- and off-road. Researchers will also incorporate haptics, bio-dynamics and psychometrics into their work. "The lab has adopted a holistic approach toward research, investigating all aspects of vehicle-terrain interactions and using a broad range of measurement, analysis and modeling tools. This allows researchers to broaden their expertise while gaining a deeper understanding of the fundamental issues involved in improving vehicle system performance," he said.

## Tim Jacobs



**Assistant  
Professor  
Texas A&M  
University**

Tim Jacobs (PhD ME '05, MSE '02, BSE '99) has accepted a faculty appointment at Texas A&M University beginning

in fall 2006. He will be part of the thermal-fluid sciences group and will teach courses in thermodynamics, heat transfer, combustion and fluids.

Jacobs will continue his research in advanced energy systems, including internal combustion engines, gas turbines, alternative fuels and catalyst systems. More specifically he hopes to investigate the fundamental characteristics of novel modes of diesel combustion and the system interactions between diesel engines and aftertreatment catalyst devices. "My goal for long term research," he said, "is to branch into

advanced powertrain systems that contribute to sustained energy usage in the transportation sector. Such systems could include hybrid designs, the use of fuel cells as electrical accessory power units and hydrogen fuel."

A "tremendously enjoyable educational career at the University of Michigan" sparked Jacobs' desire to continue academic engineering research and the education of others. "...In my experience, teaching makes me a better researcher, and thus vice versa."

He chose Texas A&M because it "effectively fosters the dual life of being a researcher and an educator." Above all, he says, is the "strong collegiality" within the mechanical engineering department. "As a beginning young faculty member, these positive intra-department personal relations provide comfort to me, as I'm sure to stumble from time to time."

Jacobs credits his time in the ME department at U-M, where he worked with Professor Dennis Assanis, for his decision to join academia. "Without this wonderful experience, I doubt I would have stayed for a graduate degree and thus would have missed out on an opportunity to become a faculty member myself. U-M is an exciting place to be regardless of your engineering discipline, and that has influenced me to become passionate about what I do in life."

## Charles J. Kim



**Assistant  
Professor  
Bucknell  
University**

Charles J. Kim (MSE ME '02; PhD ME '05) joined the faculty of Bucknell University in

August 2005 as an assistant professor.

Kim's primary area of research is the design synthesis of compliant mechanisms. At Bucknell he has further developed the methodologies in his doctoral dissertation.▶

“A Conceptual Approach to the Computational Synthesis of Compliant Mechanisms.” Kim was advised by U-M Professor Sridhar Kota and Yong-Mo Moon, an assistant professor of mechanical engineering at Worcester Polytechnic Institute. Kim also has been working on the design of surgical instrumentation and the design of appropriate technologies for developing countries.

Bucknell’s strong focus on undergraduate education was a natural fit for Kim. “At the university, college and department levels teaching is the first priority,” he said. “Among undergraduate institutions without PhD programs, the College of Engineering at Bucknell ranks among the elite and, as a result, the quality of the students is high. Expectations of research are also high considering the time appropriated for scholarly activities.”

At Bucknell, Kim has taught junior-level solid mechanics and mechanical design and will teach sophomore dynamics and the senior capstone design course in 2006-2007. During his graduate studies at U-M he served as a graduate student instructor for several courses and the primary instructor of two.

## Chuan Li



**Associate Professor**  
**Nanyang Technological University**

Chuan Li (PhD MEAM '97; MS MEAM '93) has been promoted to the rank of associate professor in the

School of Mechanical and Aerospace Engineering at Nanyang Technological University in Singapore.

Li joined the faculty of Nanyang Technological University in 2000 as an assistant professor. His research interests include stability analysis of dynamic systems, thermal-mechanical coupled stability analysis, heat transfer, residual stress analysis in casting processes and power electronics packaging design. The subject of his dissertation at U-M was thermoelastic contact stability analysis.

Prior to joining the NTU faculty, Li worked as an engineer for DaimlerChrysler Corporation

in Detroit in Jeep/Truck Engineering - Powertrain CAE/Simulation. He also spent a year working with Ford Motor Company in Dearborn, Mich., as a product development engineer with Visteon’s Alternative Power Systems division.

Li began his teaching career during his doctoral studies at U-M, when he served as a teaching assistant for Introduction to Dynamics and Introduction to the Mechanics of Materials. He says he is appreciative of his own education at U-M in shaping the educator he is today. “It means a lot to me, way beyond receiving a diploma. The ME faculty granted me an opportunity to realize what I know and, even more importantly, what I don’t know.”

Li earned his bachelor’s degree in hydraulics and ocean engineering from National Cheng Kung University in Tainan, Taiwan.

## Geoff Rideout



**Assistant Professor**  
**Memorial University of Newfoundland**

Geoff Rideout (PhD ME '04) has joined the Faculty of Engineering and Applied Science, Memorial University

of Newfoundland, as assistant professor. His appointment became effective in January 2006.

Rideout’s research program at Memorial University encompasses investigations of automated model generation and simplification, with applications to interdisciplinary areas such as robotic, land and sea vehicles. His work more generally includes dynamic system modeling, automated modeling, bond graphs and vehicle dynamics.

Rideout is not new to teaching. During his doctoral work at U-M he served as a graduate student instructor mentor through the Center for Research on Learning and Teaching. At Memorial University he will teach courses in his areas of expertise: mechanical component design, theory of machines and mechanisms, modeling and simulation of dynamic systems, and machine dynamics.

He is looking forward to teaching at the institution where he spent his undergraduate years, as well as to the university’s “balanced emphasis on teaching and research.” After completing his undergraduate studies, he earned a master’s degree at Queen’s University in Kingston, Ontario.

Receiving his PhD from U-M was “instrumental” in helping Rideout secure his new faculty position. “I found U-M professors accessible and helpful despite their status and the demands placed on them, and generally good teachers as well. The breadth of graduate course offerings was an advantage that U-M provided. The high-quality infrastructure and support staff made it easy to get work done. Orientation sessions were thorough, and there was always someone to help with any question. My office space as a graduate student was also generous, in an open-concept lab where communication with other grad students was easy.”

When applying to the Natural Sciences and Engineering Research Council of Canada for academic grants, Rideout recalled, “Some of my reviewers noted that I had U-M training, and that it was a predictor of future research success.”

## Xiulin Ruan



**Assistant Professor**  
**Purdue University**

Xiulin Ruan (MS EE '06; PhD ME '06) joins the faculty of Purdue University in January 2007 as an

assistant professor in the School of Mechanical Engineering.

“The new energy center and nanotechnology center at Purdue’s College of Engineering have been formed, and I will be affiliated with them,” said Ruan, who is looking forward to his appointment. “The School of Engineering also has an active heat transfer research group, which I will participate in.”

His area of focus is heat transfer physics. “With the knowledge of atomic scale behavior of energy carriers — phonon, electron, photon, fluid particles — one can design new functional materials or structures with the



desired size effect. These new materials will play a crucial role in energy-related applications in the next decade. I will work on how to enhance conversion efficiency through the use of nanostructures.”

Ruan will teach undergraduate courses in thermodynamics, fluid mechanics and heat transfer and, at the graduate level, radiation heat transfer, lasers and optics. He will also develop a new Heat Transfer Physics course.

“My time at Michigan certainly has had a tremendous impact on me,” he said. “My advisor, Professor Massoud Kaviany, gave me sufficient freedom to explore fundamental and innovative problems, while I can still benefit a lot from his expertise and insight. I also assisted in writing a research proposal based on my work to the National Science Foundation, and it was funded. These trainings, normally only available to postdocs, were unusually valuable for a PhD student.”

## Fu Zhao



**Assistant  
Professor  
Purdue  
University**

Fu Zhao (PhD ME '05; MS EE '01) joins the School of Mechanical Engineering at Purdue University as an assistant

professor in January 2007.

Currently Zhao is a post-doctoral research fellow at U-M's Environmental and Sustainable Technologies Laboratory, headed by Associate Professor Steven Skerlos.

Zhao's research is in the area of sustainable engineering, particularly developing technologies to minimize the environmental impact of industrial aqueous systems. His dissertation took metalworking fluid systems, widely used in the machine tool industry, as a case study. He presented novel technologies, including green formulation, membrane filtration and molecular-biology-based microorganism detection, to improve the sustainability of these systems. He is also interested in using supercritical carbon dioxide and ionic liquids as alternative carriers to water to improve environmental performance.

Given the interdisciplinary nature of his work, encouraged by Skerlos and the U-M experience, said Zhao, Purdue presents exciting opportunities. “Through the creation of nine multidisciplinary initiatives, including Global Sustainable Industrial Systems, that break the established boundaries among engineering disciplines, Purdue Engineering gives researchers the chance to address national priorities and perform field-defining research.”

At U-M, Zhao taught the senior design course twice and found it “very rewarding.” He will teach several design courses at Purdue and will develop a new graduate course, Life Cycle and Sustainability Engineering, focused on building the conceptual, methodological and scientific foundation for students to understand and minimize the environmental impact of engineering decisions.

“Sustainability can only be achieved if engineering students are equipped not only with technologies and tools,” he said, “but knowledge about how to use them in an environmentally-friendly manner.”

## Promotions



Yong Hoon Jang (PhD ME '99) has been promoted to associate professor in the School of Mechanical Engineering at Yonsei University in Seoul, Korea.

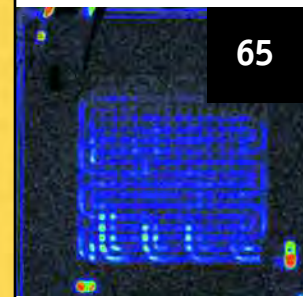



ME External Advisory Board members at their Fall 2006 meeting, which addressed globalization and engineering education.

## Global Perspectives from ME's External Advisory Board

**A**t the EAB meeting in March 2006, members shared their insights on the theme of "globalization in engineering education, research and practice." The issues surrounding globalization are at the fore both for the ME department and industry alike.

Alan Taub, EAB member and the executive director of Research & Development for General Motors, talked about the importance of university partnerships to GM's global research and engineering efforts. For example, GM's Collaborative Research Laboratory for Advanced Vehicle Manufacturing, housed in the ME department at U-M, works with a satellite laboratory at Shanghai Jiao Tong University in China. "About 30 percent of our work is done through these types of collaborations," he said.

The role of engineering education, he believes, is to — first and foremost — train students that are "well-grounded in the fundamentals of engineering, with a solid technical background." But students also need "to be amenable — to relish — the idea of working in teams and collaborating." Collaborating with colleagues from around the world, that is: "Those teams are as likely to have members that are 5,000 miles away as 100 miles away," said Taub.

EAB member Gerhard Schmidt believes that U.S. automotive companies have been some of the longest-standing global companies; they have a lot of heritage in global interaction.

Ford, for example, has had a footprint in Germany since the 1920s, he added. During a recent and typical staff meeting, he led team

members located in Japan, Germany, the United Kingdom and Sweden. "Every engineer that works in our shop has global interaction."

While study abroad exchange programs are "extremely important," he said, not every engineering student can take advantage of such programs. "It's just as important to get students from abroad into your [degree] programs." The ME department's efforts to do that are evident, he says, when he walks across U-M's North Campus. "You see the variety, the diversity."

EAB member Roger McCarthy, chairman *emeritus* of Exponent, Inc., shared his company's experience with forming a wholly owned foreign enterprise in China's Yangtze River Delta. The area is not only China's business hub but the epicenter of the world's manufacturing and construction, said McCarthy. Exponent clients have been asking the company for Asia-Pacific support, and McCarthy also sees new growth opportunities, such as providing quality assurance and factory audits, intellectual property support, design consulting and environmental consulting. The subsidiary, Exponent Science and Technology Consulting Co., Ltd. (Hangzhou), is one of the first professional engineering firms to serve China.

The opportunities overseas mean future engineers need strong leadership skills in addition to top-notch technical training. "Engineering education in the U.S. must prepare U.S.-trained engineers to be the

'leaders' of international collaboration," said McCarthy, "not just international collaborators.

"The university role in preparing engineers for the challenges of globalization boils down to preparing those engineers for a role higher up in the engineering food chain," he said. "Routine checking of plans and specifications are simply not going to be done in the U.S. anymore. That is also true of labor-intensive analyses, such as those relating to stress or temperature or code compliance. Therefore our universities better be preparing our engineers for global leadership roles — most U.S. technology is still far ahead of that of the rest of the world, and if our engineers are properly trained to be technology leaders we will retain our top position."

EAB member Ward O. Winer, chair of the Woodruff School of Mechanical Engineering at Georgia Institute of Technology and a U-M ME alumnus (PhD '62; MS '59; BS '58) and former U-M faculty member, says that preparing students for global engineering leadership roles is a responsibility of major universities. Georgia Tech, he explained, "has for some time emphasized international experience for engineering students." The university's goal is for 50 percent of students to study or work abroad during their undergraduate years.

"The bottom line," said Winer, "is that engineering students, especially those at major institutions like U-M and Georgia Tech, need to have international experience to help them become leaders in the globalized engineering profession of tomorrow."



# ME Welcomes New EAB Members

Close to twenty distinguished friends and alumni of the Department of Mechanical Engineering comprise the External Advisory Board, a valuable resource to Department Chair Dennis Assanis and the Department as a whole in shaping and meeting its strategic goals. Members represent industry, academia and government, and they meet on campus twice annually to share their expertise and to advise the chair.

Several new members joined the EAB during the 2005-2006 academic year.



**Gregory Ohl** is the manager of the Advanced Powertrain Controls Development group at DaimlerChrysler Corporation. Greg began his career with Chrysler in 1983, after earning his bachelor's degree from Lehigh University. He returned to school in 1991 to earn master's and doctoral degrees in mechanical engineering from U-M in

1992 and 1995 respectively. His research focus was the utilization of dynamic systems modeling for improving fuel cell propulsion and other alternative powertrain technologies.

Upon his return to DaimlerChrysler, Greg joined the powertrain systems and controls area. In his current position he is responsible for the advanced research and production development of controls and associated diagnostics for Chrysler Powertrain. In 2000 he initiated a research collaboration with the Department of Mechanical Engineering, which has led to the transfer of knowledge in a number of important areas, leading to the resolution of several production development issues. Greg holds several patents, has authored many technical publications and holds a Professional Engineer license in Michigan.



**Mark Perlick** serves as the vice president of Technology for BorgWarner Inc. He is responsible for driving the innovation process, managing the corporate technology investment and assuring a pipeline of new product development on a global basis. He is executive sponsor of the Technology Council and serves as an officer of BorgWarner

Incorporated. Perlick joined the company in 1999 and has held several positions, each with increasing responsibility and scope.

Prior to joining BorgWarner, Perlick spent 35 years at General Motors Corporation, starting in 1964 as a co-op student. He held numerous positions in engineering and program management. His most recent role there was chief engineer in Automatic

Transmission Engineering. Perlick holds a bachelor's degree in mechanical engineering from General Motors Institute (Kettering University).



**E. Charles Gulash** serves as vice president of Research and Materials Engineering at Toyota Motor Engineering and Manufacturing North America. Gulash earned his bachelor's degree in mechanical engineering from U-M in 1972 and an MBA from U-M in 1978. He joined Toyota in 1996 as general manager of the Toyota Arizona Proving Grounds and has been vice president of

Vehicle Evaluation and Engineering. In his current position he is responsible for materials development and leads North American advanced research activities at their laboratories in Ann Arbor, Cambridge, Mass., Berkeley, Calif. and Akin, S.C.

Prior to joining Toyota, Gulash held various engineering and management positions with General Motors Corporation. He also serves on the U-M Transportation Research Institute's External Advisory Board and the Visiting Committee at the U-M Dearborn's College of Engineering and Computer Sciences.



**Stephanie LaCrosse** currently serves as senior manager of Advanced Planning and Strategy at Nissan North America in Los Angeles. Her group is responsible for establishing the future product and powertrain line-up for the U.S. market and developing concept directions for future vehicles. Prior to joining Nissan, LaCrosse led the Advanced Electrical Technologies

Group at Hyundai-Kia Tech Center. There, she developed new vehicle technologies and strategic programs to incorporate advanced technology into Hyundai and Kia North American vehicle platforms.

LaCrosse also spent three years developing telematics systems in Silicon Valley and six years at Ford Motor Company in Dearborn. She held positions at Ford Research Labs in Materials Science and Powertrain Software Development and received a U.S. patent for her research on using neural networks to predict hydrocarbon emissions. She has successfully launched vehicles in the United States and Philippine Islands.

LaCrosse earned her bachelor's degree in mechanical engineering (1997) and a master's in Automotive Engineering (1999) from U-M, where she was inducted into Pi Tau Sigma, Tau Beta Pi and the Epeians Engineering Leadership Honor Society.

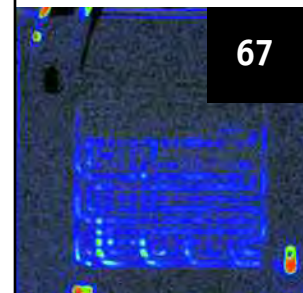

## EAB Member Taub Elected to NAE

**A**lan Taub, EAB member and executive director of Research & Development for General Motors, was inducted into the National Academy of Engineering in 2006. He was recognized for his contributions to the development of innovative electrical materials and automotive technologies and leadership in the globalization of automotive research.

Taub earned his bachelor's degree in materials engineering in 1976 from Brown University. He went on to earn master's (1979) and doctoral degrees (1979) in applied physics from Harvard University. He spent nearly 15 years in R&D with General Electric, where he earned 26 patents and authored more than 60 papers. His research focus was on the mechanical and electrical properties of materials. He later led a superconducting materials team that led technology breakthroughs that were adopted for commercial use by the company's medical group. Taub ultimately managed the GE

materials properties and processes laboratory. Later he joined Ford Motor Company, managing the Materials Science department.

He joined GM in 2001 as executive director of Science Laboratories for GM Research & Development and was named executive director of Research & Development in 2004. He oversees GM's seven science laboratories in Warren, Michigan, and Bangalore, India. The labs focus on technologies, including advanced powertrain systems; computer-based design and analysis systems for vehicle engineering; electronics and information-based vehicle systems; new materials and fabrication processes; environmentally friendly fuels and lubricants; and emission control systems.

Taub also oversees GM's technology collaborations with government, industry and university partners through many science offices worldwide and serves as liaison



between R&D and the rest of GM on advanced technology development and implementation. He has been an active member of the Materials Research Society and serves on advisory boards of several other institutions, including Harvard, Brown and Northwestern universities, Massachusetts Institute of Technology and the National Science Foundation.

## Ray Wilcox Wins Alumni Society Merit Award

**T**he Department of Mechanical Engineering has selected Raymond (Ray) I. Wilcox for the 2006 Alumni Society Merit Award in Mechanical Engineering. Wilcox earned a bachelor's degree *cum laude* from the Department in 1968. He currently serves as president and chief executive officer of Texas-based Chevron Phillips Chemical Company LLC.



Alumni Society Merit Awards are bestowed by departmental committees to recognize significant professional accomplishments.

Wilcox began his nearly-four-decade career with Chevron the year he graduated from U-M. He was hired as a design and construction

engineer. "The University attracts many good prospective employers, and that was how I found Chevron. I didn't know much about the company before interviewing, but I did so on the recommendation of a fellow student who had done an internship the previous summer," he said.

Since that time, he has held technical, operational, commercial, managerial and leadership positions with the company in the United States and abroad. He has served as vice president of Chevron Corporation and president of Chevron North America Exploration and Production Company. He has also held the positions of vice president of Chevron Shipping Company, managing director of Chevron Asiatic, Ltd., in Melbourne, Australia, and chairman and managing director of Chevron Nigeria Limited in Lagos, Nigeria. He was elected to his current position in April 2006.

Wilcox is active in many community and industry organizations. He serves on the

board of directors and the executive committee of the National Petrochemical & Refiners Association and the advisory board of Spindletop International, a not-for-profit corporation that benefits youth charities and promotes goodwill and fellowship within the oil and gas industry.

He also is a member of the U-M College of Engineering External Advisory Board. "Giving back to the University is an important way to ensure future success for the school and companies that alumni work for. I have hired quality students for my company, and my wife and I have set up a fund in the ME department to emphasize the critical importance of communication as part of a technical education. The University provides a worldwide standard for education and gives me a point of common reference with fellow alumni."

Wilcox is also an alumnus of the 1994 London Business School Senior Executive Program.



**University of Michigan  
College of Engineering  
Department of Mechanical Engineering**

2250 G.G. Brown Laboratory  
2350 Hayward Street  
Ann Arbor, MI 48109-2125

<http://me.engin.umich.edu>

Phone: 734-764-2694  
Fax: 734-647-3170

**Executive Editor**

Dennis N. Assanis

**Managing Editor**

Chris Africa

**Writing**

Outword Professional Writing, Kim Roth

**Design**

Michigan Marketing & Design

**Photo Credits**

Faculty portraits and photos not listed below were taken from the ME image archive.

*Special thanks to the following individuals and groups for their contributions:*

(p. 4) ME Academic Services Office; (p. 5) Ann Marie Sastry; (p. 8) Jun Ni; (p. 9) Hong Im; (p. 10) Volker Sick; (p. 11) Rod Hill, Engineering Research Center for Reconfigurable Manufacturing Systems; (p. 13) Deba Dutta; (p. 16) (top) Ellen Arruda and (bottom) Karl Grosh; (p. 17) Edgar Meyhöfer; (p. 18) Katsuo Kurabayashi; (p. 19) Suman Das; (p. 20) (left) Kevin Pipe and (right) Margaret Wooldridge; (p. 21) (top) Massoud Kaviany and (bottom) Wei Lu; (p. 22) William Lim; (p. 23) Hong Im; (p. 24) (left) Huei Peng and (right) Anna Stefanopoulou; (p. 25) Ann Marie Sastry; (p. 26) (top) Naval Surface Warfare Center, Carderock Division and (bottom) Steve Ceccio; (p. 27) (top) William Schultz and (center) Whirlpool Corporation; (p. 28) Steve Skerlos; (p. 30) Automotive Research Center; (p. 31) Volker Sick; (p. 32) Diann Brei; (p. 33) (top) U-M Photo Services and (bottom) Alan Wineman; (p. 34) Noboru Kikuchi; (p. 35) Tim Gordon; (p. 39-41) ERC-RMS; (p. 43) Jyoti

Mazumder; (p. 57) U-M Photo Service; (p. 62) from left: Aris Babajimopoulos, Hosam Fathy, John Ferris; (p. 63) from left: Tim Jacobs, Charles Kim; (p. 64) from left: Chuan Li, Geoff Rideout, Xiulin Ruan; (p. 65) from left: Fu Zhao, Yong Hoon Jang; (p. 66) U-M Photo Services; (p. 67) from top left: Gregory Ohl, Mark Perlick, E. Charles Gulash, Stephanie LaCrosse; (p. 68) (top) Alan Taub and (bottom) Ray Wilcox.

*Series Graphics (edges of pages):*

(p. 3-19) Krishna Garikipati; (p. 21-35) Wei Lu; (p. 37-41) Volker Sick; (p. 43-55) Margaret Wooldridge; (p. 57-67) Huei Peng.

**Regents of the University**

Julia Donovan Darlow, Ann Arbor; Laurence B. Deitch, Bingham Farms; Olivia P. Maynard, Goodrich; Rebecca McGowan, Ann Arbor; Andrea Fischer Newman, Ann Arbor; Andrew C. Richner, Grosse Pointe Park; S. Martin Taylor, Grosse Pointe Farms; Katherine E. White, Ann Arbor; Mary Sue Coleman, *ex officio*

**Affirmative Action**

The University of Michigan, as an equal opportunity/affirmative action employer, complies with all applicable federal and state laws regarding nondiscrimination and affirmative action, including Title IX of the Education Amendments of 1972 and Section 504 of the Rehabilitation Act of 1973. The University of Michigan is committed to a policy of nondiscrimination and equal opportunity for all persons regardless of race, sex,\* color, religion, creed, national origin or ancestry, age, marital status, sexual orientation, disability, or Vietnam-era veteran status in employment, educational programs and activities, and admissions. Inquiries or complaints may be addressed to the Senior Director for Institutional Equity and Title IX/Section 504 Coordinator, Office of Institutional Equity, 2072 Administrative Services Building, Ann Arbor, Michigan 48109-1432, 734-763-0235, TTY 734-647-1388. For other University of Michigan information call 734-764-1817.

\* Includes discrimination based on gender identity and gender expression.

MM&D 066678

[me.engin.umich.edu](http://me.engin.umich.edu)

DEPARTMENT OF MECHANICAL ENGINEERING